



GLEN DIMPLEX
AUSTRALIA PTY LTD

BELLING FSE 60 I
SERVICE MANUAL



think of everything

INDEX

<u>PRODUCT IDENTIFICATION</u>	PAGE
APPLIANCE RATING PLATE	3
<u>USER GUIDE AND INSTALLATION HANDBOOK</u>	
USER GUIDE.....	4-47
INSTALLATION INSTRUCTIONS.....	47-51
TECHNICAL DATA.....	52-52
WIRING DIAGRAMS.....	53-54
CONTACT DETAILS.....	59-59
PARTS LIST FSGE 60 I.....	60-65
<u>REPAIR AND MAINTAINANCE</u>	
DISASSEMBLY PROCEDURES.....	68-74
COMPONANT REMOVAL.....	75-83
TECHNICAL SPECIFICATIONS.....	84-84
FAULTFINDING GUIDES.....	85-86
INDUCTION TRAINING PRESENTATION.....	87-98

THIS MANUAL COVERS THE FOLLOWING MODELS :-

FSE 60 I

PRODUCT IDENTIFICATION

Appliance rating plate location

The appliance rating plate is located on the right-hand side of the front frame and also on the rear service panel

9	10	1	8	4	3	2	8
---	----	---	---	---	---	---	---



YEAR

MONTH

NUMBER OF PRODUCTION
FOR THE MONTH

4	4	4	4	4	0	0	2	8
---	---	---	---	---	---	---	---	---

PRODUCT IDENTIFICATION CODE

It is important that during all service calls the model and serial numbers are recorded on all paper work.



Whatever the occasion

bellin[®]

think of everything

Our Warranty

Should you need it

Inside the paperwork which has come with this appliance, there is a leaflet and card explaining the terms of our extended warranty and guarantee.

In order to apply for our five year guarantee, simply fill in the details on the card and post it off, this will register your appliance.

Should you wish to take out extended warranty, please fill in the details on the leaflet and post this off to:

Glen Dimplex Australia
Unit 2, 205 Abbots Road
Dandenong South
Victoria 3175
Australia

Ph: 1300 556 816
Fx: 1800 058 900

Glen Dimplex New Zealand Pty
38 Harris Road, East Tamaki
Auckland
New Zealand

Ph: 09 274 8265
Fx: 09 274 8472

If your appliance is covered by the warranty and guarantee, you will not be billed for work undertaken should your appliance be faulty, terms and conditions do apply, so please read through the literature carefully.

Please ensure that you have available your appliances model number and serial number, there is a space at the back of this book for recording that information.

IMPORTANT NOTICE

Please note the cooling fan fitted to this appliance is an integral part of its safety and functionality.

When the appliance is installed care must be taken that the cooling fans performance is not impeded by any objects coming into contact with it. (Installation pipes, leads etc) Care must also be taken that there is sufficient air flow at the rear of the appliance for the cooling fan to run at its optimum efficiency. (Particularly Built In appliances) See clearance dimensions in the installation section of the booklet.

During use the Appliance must never be disconnected from the Mains supply as this will seriously affect the safety and performance of the appliance, particularly in relation to surface temperatures becoming hot and gas operated parts not working efficiently.

The cooling fan is designed to run on after the control knob has been switched off to keep the front of the appliance and the controls cool until the appliance has naturally cooled itself.

CONTENTS

User Section	2 - 42
Introduction	2
Be Safe - Not Sorry	4
Using the induction hob	7
Oven & Grill functions	16
Using the grills	17
Using the top oven	20
Using the multi-function main oven	23
Using the main oven	24
Using the ovens	31
Programmer/Clock	35
Care & cleaning	40
Installation Instructions	43
Technical Data	47
Belling Customer Care	Back page

Please keep this handbook for future reference, or for anyone else who may use the appliance.

INTRODUCTION

Thank you for choosing a British built appliance by Belling.

We hope that the following information will help you to quickly familiarise yourself with the features of the appliance, and to use it successfully and safely.

Our policy is one of constant development and improvement. Strict accuracy of illustrations and specifications is not guaranteed. Modification to design and materials may be necessary subsequent to publication.

This cooker may be sited with cabinets on both sides, or it may be free standing. Sufficient space should be allowed at either side of the cooker to enable it to be pulled out for cleaning and servicing.

Please read the instructions in this handbook before using or installing this appliance. All installation and servicing work must be carried out by a competent person.

Your 1st Year Guarantee

To fulfil the conditions of your guarantee, this appliance must be correctly installed and operated, in accordance with these instructions, and only be used for normal domestic purposes.

Please note that the guarantee, and Service availability, are only available in the UK and Republic of Ireland.

Moving the cooker

Do not attempt to move the cooker by pulling on the doors or handles. Open the oven or grill door and grasp the frame of the cooker, taking care that the door does not shut on your fingers.

Take care to avoid damage to soft or uneven floor coverings when moving the appliance. Some cushioned vinyl floor coverings may not be designed to withstand sliding appliances without marking or damage.

Before using the appliance for the first time, remove any protective polythene film and wash the oven shelves and shelf runners in hot soapy water to remove their protective coating of oil. Even so, when you first turn on the oven or grill you may notice a smell and some smoke.

Glass door panels

To meet the relevant Standards of Domestic cooking appliances, all the glass panels on this appliance are toughened to meet the fragmentation requirements of BS3193. This ensures that, in the unlikely event that a panel breaks, it does so into small fragments to minimise the risk of injury.

Please take care when handling, using or cleaning all glass panels, as any damage to the surfaces or edges may result in the glass breaking without warning or apparent cause at a later date. Should any glass panel be damaged, we strongly recommend that it is replaced immediately.

INTRODUCTION

The cooling fan

When the appliance is operated, the cooling fans will automatically operate. This keeps the fascia, control knobs and components cool during cooking.

The cooling fan may continue to operate for a period of time after the controls have been switched off.

When hot and cold air meet, condensation forms. Some condensation may form on doors or on the fascia glass. This is normal and will disappear within 10 - 15 minutes.

Environmental Protection

We are committed to protecting the environment and operate an Environmental Management System which complies with BS EN ISO 14001.

Disposal of packaging

- All our packaging materials are recyclable and environmentally friendly.
- Please help us to protect our environment by disposing of all packaging in an environmentally friendly manner.
- Please contact your local authority for the nearest recycling centre.

Caution: Packaging materials can pose a risk of suffocation - keep away from children.

Electrical connection

Please refer to installation instructions for electrical connection.

In your own interest, and that of safety, make sure that the installation is carried out by a competent person.

Disconnection of electric appliances should always be carried out by a competent person.

Warning: This appliance must be earthed.

To replace an oven light bulb

Caution: Switch off the electricity supply to the cooker at the socket, to avoid the risk of electric shock.

Wait until the oven is cool, then remove the shelves.

The oven light is at the rear of the oven cavity.

Remove the loose oven back - unscrew the 4 securing screws (one at each corner).

Unscrew the lens cover (turn anticlockwise). Unscrew the bulb and replace. Replace lens cover.

Replace oven back.

Please note that the oven light bulb is not covered by the guarantee. Replacement bulbs can be ordered from your local supplier, or bought from a hardware store.

BE SAFE - NOT SORRY

When you are cooking, keep children away from the vicinity of the appliance.

This product is designed as a domestic cooking appliance for the preparation and cooking of domestic food products, and should not be used for any other purpose.

- Make sure you read and understand the instructions before using the appliance.
- Remove all packaging, protective films and oils from the appliance before using for the first time.
- Before using the hob for the first time, remove all packaging, protective films, oils and stickers from the glass ceramic.
- Apply a thin coating of cleaner conditioner and polish the surface with a clean dry cloth.
- The conditioner gives a protective covering to the ceramic glass which not only makes the hob easier to clean, but also ensures you will gain maximum life out of this product.
- Risk of burns - do not place objects made of steel, such as knives, forks, spoons and saucepan lids on the cooking surface, as they can get very hot.
- **Warning!** do not clean the appliance with a steam jet or high-pressure cleaning equipment.
- Keep electrical leads short so they do not drape over the appliance or the edge of the worktop.
- Keep all flammable materials (such as curtains, furnishings & clothing) away from the appliance.
- Never use the appliance for heating a room.
- Parts of the appliance may be hot during or immediately after use. Care should be taken to avoid touching heating elements inside the oven. Allow sufficient time for the appliance to cool after switching off.
- Do not use the oven with the door inner glass panel removed.
- Do not drape tea towels over the flue vents or doors, as this creates a fire hazard.
- Switch off the electricity supply before replacing the oven light bulb, to avoid the risk of electric shock.
- Do not use aluminium foil to cover the grill pan, or put items wrapped in foil under the grill, as this creates a fire hazard. The high reflectivity can also damage the element.
- Do not use foil on oven shelves, or allow it to block the oven flue, as this creates a fire hazard, and prevents heat circulation.

BE SAFE - NOT SORRY

- When cooking heavy items - eg; turkeys - do not pull the oven shelf out with the item still on the shelf.
- When opening the appliance door, take care to avoid skin contact with any steam which may escape from the cooking.
- Use oven gloves when removing hot food / dishes from the oven or grill. The oven / grill and utensils will be very hot when in use.
- The glass ceramic can get hot whilst cooking; the cook zone itself does not generate heat. The heat generated is conducted back from the hot pans.
- This induction hob complies with the applicable EMC and EMF standards. Therefore it should not interfere with other electronic units. Persons fitted with a pacemaker or any other electrical implant should clarify with their doctor or the producer of the implant, whether there implant is adequate and fail-safe, the pacemaker must be designed in compliance with the appropriate regulations.
- It's important that good quality flat bottomed pans are used, if a pan creates a large air gap over the middle of the cooking zone, the accuracy of the temperature sensing can be affected.
- If you use a griddle plate ensure it is completely cool before attempting to lift it from the hob as residual heat may cause burns. Always use

oven gloves to protect your hands.

- Don't leave pans on the hob when you're not around - take them off the cook zone if you have to leave the kitchen (even if you think it will only be for a moment)
- If you're called away from the cooker - by the phone or someone at the door, either take pans off the heat or switch off your hob.

Warning! Do not use the hob if the ceramic glass surface is cracked or broken, as electrical parts are immediately beneath. Switch of the appliance at the supply and contact your supplier

Warning: This appliance must be earthed.

- All installation, servicing and maintenance work should be carried out by a competent person who will comply with current Regulations, Standards and Requirements.
- **When you have finished cooking check that all controls are in the off position.**

WARNING! -Accesible parts may become hot during use. To avoid burns, young children should be kept away from the appliance.

Call Customer Care for a Service Engineer's visit if:

You find that the oven becomes hotter at a particular temperature - the thermostat may need replacing.

The Cooling fan fails to work

BE SAFE - NOT SORRY

Smoke alarm - buy a smoke alarm fitted with a 'hush button' which can silence the alarm instantly should it activate accidentally & does not necessitate the removal of the battery (except to change for a new one).

Fire Blanket - consider having a fire blanket in your kitchen, mounted on the wall where you can get to it easily & quickly.

Deep-fat Frying - never fill a chip pan (or other deep-fat fryer) more than one-third full of oil. If you do have a chip pan fire:

- 1) call emergency services
- 2) never move the pan
- 3) turn off the heat but only if it is safe do so
- 4) never use water on a chip pan fire as this will create a fireball.

Kitchen Fire - if you have a fire in the kitchen, do not take risks - get everybody out of the house & call Emergency services. If a pan catches fire:

- 1) do not move it - it is likely to be very hot
- 2) turn off the heat but only if safe to do so & never lean over a pan to reach the controls
- 3) if you have a fire blanket, put it over the pan
- 4) do not use a fire extinguisher on a pan of oil - the force of the extinguisher can spread the fire
- 5) if you have managed to extin-

guish the fire, allow the pan to cool completely.

Electrical Fire - if you have an electrical fire in the kitchen:

- 1) pull the plug out or switch off the power at the fuse box - this may be enough to extinguish the fire immediately
- 2) smother the fire with a fire blanket or use a dry powder or carbon dioxide extinguisher
- 3) remember: never use water on an electrical fire.

Children should be supervised to ensure that they do not play with the appliance.

This appliance is not intended for use by persons (including children with reduced physical, sensory or mental capabilities, or lack of experience and knowledge) unless they have been given supervision or instruction concerning use of the appliance by a person responsible for their safety.

WARNING:- Servicing should be carried out only by authorised personnel.

Do not spray aerosols in the vicinity of this appliance while it is in operation

Do not store or use flammable liquids or items in the vicinity of this appliance.









Do not modify this appliance.

USING THE HOB

Using the hotplate

- Commercial simmering aids should not be used as they create excessive temperatures that can damage the surface and may cause a hazard.
- Do not place aluminium foil or plastic utensils on the ceramic glass, as they may melt and damage the surface.
- Do not use the ceramic glass hotplate surface for storage.
- When cooking with fat or oil, never leave unattended.
- Turn pan handles to a safe position, so they are out of reach of children, not overhanging the appliance, and cannot be caught accidentally.
- Position pans over the centre of the hotplate elements.
- Do not use the hob as a chopping board or a storage area, as this increases the likelihood of it being damaged - eg; plastic utensils placed on a warm hob may melt onto it, and damage the ceramic glass surface.
- Be careful when cooking foods in salted water, or foods containing large amounts of sugar, syrup or jam - if they are spilt onto hot areas of the hob they may damage it.
- Lift pans onto and off the surface, rather than sliding them across the surface, to avoid marks and scratches.
- If you use a wet paper towel to remove spills from a warm heating area of the hob, be careful to avoid steam burns.
- Do not use abrasive powder cleaners, metal wire wool pads, impregnated plastic pads, detergents, bleaches, bath stain removers, or chemical oven cleaners; all these types of products will damage the ceramic glass.

INDUCTION HOB FUNCTIONS

Feature	Symbol	Description
Eco Power		Induction Power is the most energy efficient means of cooking food on a hob, provides fast heat up and boiling times
Rotary Controls		Simple knob control with all the benefits of induction technology
Digital Display		Secret till "lit" hob display
No. of power levels	11	Precise and repeatable control settings
Keep Warm/ Low Temperature		Holds the pan temperature at approximately, ideal for melting chocolate "mmm choc-ol-ateee"
Auto Heat Up (4 Zones)		Automatically heats up and turns down the power to a lower setting. Helps to take the worry out of pans boiling over and burning food
Power Boost		Temporarily boost the power to a cook zone by a massive 60%
Griddle zone	Yes	Flexibility is what counts. Place pans across the LH cook zones. This is ideal for large griddle plates and pans
Pan Detection		Lets you know if the correct pans are being used and helps to save energy. When a pan is lifted off the zone, the power is automatically cut.
Overheat Pan Detection	Yes	Helps prevent cookware from overheating providing an additional level of safety not available on other types of hobs
Child lock	L	Prevents unintentional operation of the hob
Residual Heat Indicators		Warns you against hot surfaces but also indicates that there is residual heat which can be used as a temporary warm zone
Holiday Shutdown	Yes	Rest assured this hob will eventually turn it self off if left

USING THE INDUCTION HOB

About the induction hob

The induction hob provides the most energy efficient hob technology available.

The induction system provides superior heat up and cool down times for pans - you get fast, precise, repeatable power control.

As induction only heats up the pan, there is no lost heat from the cooking process, which in turn, limits the heat generated in the kitchen.

Auto Power Tuning

Induction hobs have a unique power tuning systems that automatically tunes the power to the size of the pan base this ensures energy isn't wasted.

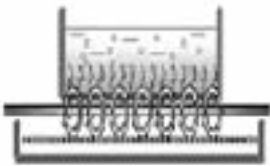

Small Pan

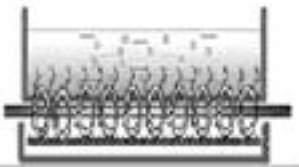

Large Pan

USING THE INDUCTION HOB

Induction controls

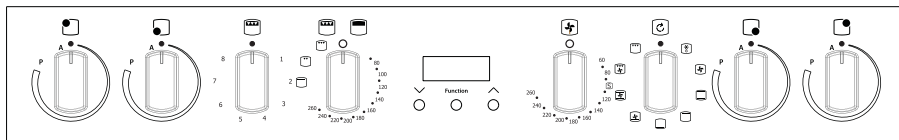

To turn the hob 'ON' / 'OFF'

To turn the hob 'ON' turn the control knob clockwise to set the cook zone to the desired power setting (1 to 9). The power display will automatically light up.

To turn the hob 'OFF' turn the control knob anti-clockwise to the 'OFF' position.

Auto Heat Up *A*

Helps to take the worry out of pans boiling over and burning food! No need to stand over the pan, allows you to do other tasks whilst maintaining control over the pan.

The Auto Heat Up is activated by rotating the control knob anti-clockwise and holding for a couple of seconds until the *A* symbol lights up in the display area, then by rotating the control knob to the required turn down setting.

The Auto Heat Up delivers full power (9) to the zone for a fixed period of time before automatically turning back down to the desired setting.

The Auto Heat Up has been tuned to provide the best boost period for each setting.

Average Auto Heat up time is 3 minutes.

Power Setting	Suggested food type	Auto Heat Up time (mins)
Low temp U °C	Melting chocolate	n/a
1	Milk, Soup Stews, Vegetables	1
2		2.5
3		4
4	Rice, Potatoes, Pasta	5
5		7
6	Frying, fish fingers Pancakes, Steaks	2
7		3
8		4
9	Full power	n/a
Boost	Full power +60%	n/a

USING THE INDUCTION HOB

Power Boost

Rev up your hob with this feature, temporarily boost the power to a cook zone by a massive 60%.

The power boost is a function that can be used to temporarily boost the normal maximum power for a cook zone by borrowing the available power from a “paired zone”.

All the cook zones have this function apart from the “Griddle Zone ” function.

The Power Boost is activated by rotating the control knob clockwise past power setting 9 and holding for a couple of seconds until  lights up in the display area. Power Boost is now activated.

The hob is split into “two paired areas”.

LH Area (LHF and LHR Cook Zone) and RH Area (RHF and RHR Cook Zone).

Only one cook zone per area can be boosted at anyone time.

Note The Power Boost function will only operate for a limited time and is also under thermal control. This means the power boost will deactivate automatically if the product is hot, to protect the internal electronic components of the hob and to prevent the cookware from overheating.

Cook Zone	Normal Max Power (9) kW	Boosted Power kW	Maximum Permissible Setting on Paired Zone
LHF	1.85	3.00	8 (LHR)
LHR	1.85	3.00	8 (LHF)
RHF	1.40	2.20	8 (RHR)
RHR	2.30	3.70	6 (RHF)

USING THE INDUCTION HOB

Griddle Zone

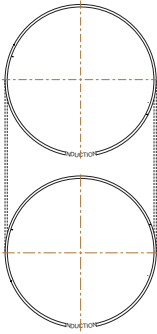

Flexibility is what counts.

The LH zones can be used as two separate round cooking zones which can be controlled individually creating a hot and cold zones on a griddle or the power settings can be matched to provide an even heat.

Large pans and griddle plates can be placed across the two zones.

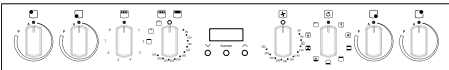

Keep Warm

The Keep Warm setting is found between power setting 0 and 1. Rotate the control knob clockwise until the  symbol appears on the display.

Pan detection

When a zone has been activated but no pan has been placed on the cook zone, this means the hob only uses power when a suitable pan is placed on the zone, this reduces the energy used during the cooking process, i.e. when you take your pan off the zone the hob automatically reduces the power, and only switches back on when you replace the pan.

Note If the  symbol does not disappear when a pan is placed on the zone it indicates that the pan is not suitable for induction cooking.

Get a magnet to check the pans.

Pan Sizes

Cook Zone	Smallest Recommended Pan Diameter
LHF	145 mm
LHR	145 mm
RHF	120 mm
RHR	180 mm

USING THE INDUCTION HOB

Cookware for induction hobs

Cookware for induction cooking zones must be made of metal and have magnetic properties. The base must also be the correct diameter.

Suitable Cookware for Induction Hobs	Unsuitable Cookware
Enameled steel pots with a thick base	Pots made of copper, stainless steel, aluminium, oven-proof glass, wood ceramic and terracotta
Cast Iron pots with an enameled base	
Pots made of multilayer stainless steel, rustproof ferrite steel or aluminium with a special base	
Pans marked for use with induction	

How to establish the suitability of a pan

Check your pans with a magnet. If it sticks and it's the correct diameter, it's suitable for use with induction. Also with pans that bear the symbol for suitability for cooking with induction.

Note - when using certain pans, you may get various noises from the pans. This is due to the design of the pans and does not effect the performance or safety of the hob.

USING THE INDUCTION HOB

Child Lock **L**

Stops the “kids” messing with your lovely induction hob.

This feature is to help prevent accidental switching on of the hob, especially by young children.

To activate/deactivate, simultaneously rotate the Left Hand Rear and Right Hand Rear control knobs to the Auto Heat Up setting for a couple of seconds. **L** will light up in the display area for all cook zones to show activation. Follow the same procedure to deactivate and the **L** symbol will disappear from the display area.

Residual Heat indicators **H**

If when the cook zone is switched off the glass surface is above 60°C, **H** will be displayed in the cook zone display until the glass surface drops below approx 55°C.

This feature not only warns you against hot surfaces but also indicates that there is residual heat which can be used as temporary warm zone.

Note - The cook zone itself does not heat up, but the ceramic glass does get hot because of the hot pan conducting heat back onto the hob glass.

Overheat Pan Protection

The hob is equipped with additional safety systems that help to prevent cookware from overheating, provid-

ing an additional level of safety not available on conventional hobs (such as gas and ceramic hobs).

Approx. Glass Surface Temperature (Approx °C)	Intelligent hob safety system
200	Reduces Power Boost setting to Power Level 9
250	Reduces power to 60% of power level setting
270	Switches cook zone off
300	Switches whole appliance off

Note - The safety temperature control of the pans is only possible with quality flat bottomed pans suitable for induction cooking. Poor quality pans can create air gaps between the glass and the pan, which affects the accuracy of the temperature control.

Auto Stand by (Holiday Shut Down)











Have you ever gone on holiday and wondered if you have switched off the hob? No need to worry about leaving your hob on with the most advanced cooking system available - the hob will automatically switch itself off if left unattended.

USING THE INDUCTION HOB

Troubleshooting with the Induction Hob

Code	Problem	Possible Cause	Solution
	Hob is not working L in display	Child lock is activated	Deactivate child lock
	Power boost not working	The appliance is hot, power boost is deactivated when the appliance is hot to protect the electronics and prevents pans from overheating	Allow the appliance to cool
ER21	Control unit cuts off after program setting	Electronics overheating	Allow the appliance to cool
ER400			Check mains cable connection and terminals at the terminal block are wired correctly
E2	Overheating of induction coil	Pan overheating	Remove pans and allow to cool
E8	Fan blocked or faulty	Fan inlets are blocked or faulty fans	Clean fan inlet at the rear of the appliance

OVEN & GRILL FUNCTIONS

Function		Recommended Uses
	Base Heat Only	Used to finish off the bases of food following cooking using the conventional or fanned modes. The base heat can be used to provide additional browning for pizzas, pies and quiche. Use this function towards the end of cooking.
	Top Heat Only	The heat is ideal for browning off the tops of food as it is not as fierce as the grill following conventional or fanned cooking. Provides additional browning for dishes like lasagne or cauliflower cheese. Use this function towards the end of cooking.
	Conventional Oven	This function is ideal for traditional roasting. The meat is placed in the middle of the oven, roast potatoes towards the top.
	Intensive Bake (Pizza Setting)	Ideal for pizzas and also suitable for food with a high moisture content, such as quiche, bread and cheesecake. It also eliminates the need for baking pastry blind.
	Fanned Grill	The fan allows the heat to circulate around the food. Ideal for thinner foods such as bacon, fish and gammon steaks. Foods do not require turning. Use with the oven door closed.
	Fanned Oven	The even temperature in the oven makes this function suitable for batch baking or batch cooking foods.
	Defrost	To defrost foods, such as cream cakes/gateaux, use with the oven door closed. For cooling dishes prior to refrigeration, leave the door open.
	Dual Grill	This function cooks food from the top and is ideal for a range of food from toast to steaks. As the whole grill is working, you can cook larger quantities of food.
	Single Grill	For smaller quantities of food, but is still ideal for anything from toast to steaks.
	Base Heat with Fan	Used to cook open pies (such as mince pies) the base element ensures that the base is cooked while the fan allows the air to circulate around the filling - without being too intensive.

USING THE GRILLS

Caution: Accessible parts may be hot when the grill is used, young children should be kept away.

Using the grills

This appliance has a grill in both oven cavities.

The top oven grill is a fully variable dual element grill.

The main oven features variable grilling - with a single element conventional grill, and a fanned grill function.

Follow the instructions given on the next page when operating these grills.

Preheating

For best results, preheat the grill for 3 - 5 minutes.

Aluminium foil

Using aluminium foil to cover the grill pan, or putting items wrapped in foil under the grill can create a fire hazard, and the high reflectivity can damage the grill element.

Detachable grill pan handle

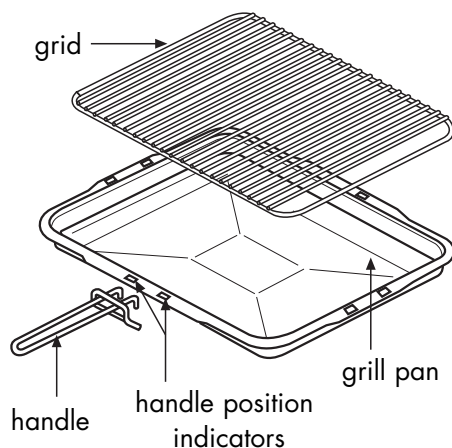

Place the handle over the edge of the grill pan, at the narrow side edges. Slide the handle to the centre, and locate between the handle position indicators.

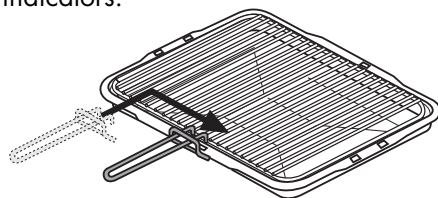

The handle should be removed from the pan during grilling, to prevent overheating.

The handle is designed for removing / inserting the grill pan under the grill when grilling.

If cleaning the grill pan when it is hot, use oven gloves to move it. *Do not* use the handle to pour hot fats from the grill pan.

Food for grilling should be positioned centrally on the trivet.

USING THE GRILLS



Grilling in the top oven

Caution: Accessible parts may be hot when the grill is used, young children should be kept away.

The top oven grill is a fully variable dual element grill.

To switch on the grill

Open the top oven / grill door.

Turn the top oven control knob past the oven temperature markings to either the single economy grill  symbol, or the dual grill  symbol.

The grill regulator - to the left of the top oven control - must then be switched on. This enables variation of the heat output from the grill on either the single grill or dual grill settings.

The dual grill uses all of the top element, and the single economy grill setting uses the inner part of the element only.

Important: The door must be kept open when the grill is used.

To switch off, return the control knob to the "off" position.

Note that the grill will not operate if the top oven is switched on.

Using the top oven grill

For grilling smaller quantities of food the (single element) economy grill can be utilised. This grill function can be controlled between settings 1 and 8.

For grilling larger quantities of food, the (dual element) full grill can be utilised. The full grill can also be controlled between settings 1 and 8.

When using the grill in the top oven, the speed of grilling can be controlled by use of either the variable control or by selecting higher or lower shelf position.

For toasting, and for grilling foods such as bacon, sausages or steaks, use a higher shelf position.

For thicker foods such as chops or chicken joint pieces, use a middle to low shelf position.

The cooling fan

When the grill is switched on, you will hear the cooling fan come on - this keeps the fascia and control knobs of the appliance cool during grilling. The fan may continue to operate for a period after the grill control has been switched off.

USING THE GRILLS

Grilling in the main oven

Caution: Accessible parts may be hot when the grill is used - young children should be kept away.

The grill / fanned grill settings use the inner element only.

Conventional grill



The door must be closed when the grill is used for conventional grilling.

When opening the door, take care to avoid skin contact with any steam which may escape from the cooking.

- (i) Turn the selector control knob to the conventional grill setting.
- (ii) Turn the temperature control knob to the desired temperature for grilling, similar to oven function. However, do not set to a temperature greater than 230°C.

Fanned grill



The door must be closed when the fanned grill is used.

When opening the door, take care to avoid skin contact with any steam which may escape from the cooking.

- (i) Turn the selector control knob to the fan grill setting.
- (ii) Turn the temperature control knob to the desired temperature up to 230°C.

Fanned grilling may be faster than conventional grilling because air is being circulated around the food. Thin portions of food, such as bacon or fish fillets, may not need turning.

For best results, preheat the grill for 3 - 5 minutes.

Note that when grilling, the door must remain closed before and after grilling, and the temperature control must not exceed 230°C.

Grilling in the main oven

The speed of grilling can be controlled by selecting a higher or lower shelf position.

For toasting, and for grilling foods such as bacon, sausages or steaks, use a higher shelf position.

For thicker foods such as chops or chicken joint pieces, use a middle to low shelf position.

USING THE TOP OVEN

When you are cooking keep children away from the vicinity of the oven.

Caution: The top element gets extremely hot when in use, so take extra care to avoid touching it.

The top oven is a conventional oven

Note: The top oven is not controlled by the programmer.

To turn on the top oven

Turn the temperature control knob clockwise until the required temperature is selected.

The red thermostat indicator will come on until the selected temperature is reached, and then go off; it will turn on and off periodically as the thermostat operates to maintain the selected temperature.

To switch off, return the top oven control knob to the off position.

Important: Never put items directly on the base of the oven, or cover the oven base with foil, as this may cause the element to overheat. Always position items on the shelf.

Top heat only

Turn the top oven selector past the oven temperature markings to the top heat symbol. This fixed heat setting can be used to brown the top of dishes such as cauliflower cheese or baked alaska.

The cooling fan

When the top oven is switched on, you will hear the cooling fan come on - this keeps the fascia and control knobs of the appliance cool during cooking. The fan will continue to operate for a period after the oven control has been switched off.

Preheating

The oven must be preheated when cooking frozen or chilled foods, and we recommend preheating for yeast mixtures, batters, soufflés, and whisked sponges.

Preheat the oven until the indicator light switches off for the first time, this will take up to 20 minutes depending on the temperature selected.

If you are not preheating the oven, the cooking times in the following guide may need to be extended, as they are based on a preheated oven.

USING THE TOP OVEN

Shelf positions

There are 2 shelf positions which are counted from the bottom of the oven upwards, so shelf position 1 is the lowest.

When cooking frozen or chilled food, use the highest possible shelf position, while allowing some clearance between the food and the top element.

The oven shelf must be positioned with the upstand at the rear of the oven and facing up. Position baking trays and roasting tins on the middle of the shelves, and leave one clear shelf position between shelves, to allow for circulation of heat.

When using the top oven

As part of the cooking process, hot air is expelled through a vent at the top of the oven(s). When opening the oven door, care should be taken to avoid any possible contact with potentially hot air, since this may cause discomfort to people with sensitive skin. We recommend that you hold the underneath of the oven door handle.

Using the Top Oven

Top oven baking guide

Cooking times

These times are based on cooking in a preheated oven.

These cooking times are approximate, because the size and type of cooking dish will influence time as well as personal preferences.

Shelf positions

As a general guide, when cooking frozen or chilled food, use the highest possible shelf position, while allowing some clearance between the food and the top element. Follow the instructions given on packaging.

Cooking temperatures

The temperature settings and time given in the Baking Guides are based on dishes made with block margarine. If soft tub margarine is used, it may be necessary to reduce the temperature setting. If a recipe gives a different temperature setting to that shown in the guide, the recipe instruction should be followed.

Because the top oven is more compact, it may be necessary to reduce cooking temperatures specified in recipes by up to 20°C.

Use the baking guide as a reference for determining which temperatures to use.

Item	Temperature °C	Shelf position	Approximate cooking time
Small cakes	180	1	15 - 20 mins
Victoria sandwich (2 x 180mm / 7")	160	1	20 - 25 mins
Swiss roll	200	1	8 - 12 mins
Semi rich fruit cake (180mm x 7")	140	1	2¼ - 2¾ hours
Scones	215	1	10 - 15 mins
Meringues	90 - 100	1	2 - 3 hours
Shortcrust pastry	200 - 210	1	Depends on size & type of cooking dish & also the filling
Puff / flaky pastry	200 - 210	1	
Choux pastry	200 - 210	1	
Biscuits	160 - 200	2	10 - 20 mins
Sponge pudding	150	1	30 - 45 mins
Milk pudding	140	1	2 - 2½ hours

USING THE MULTI-FUNCTION MAIN OVEN

Caution: Accessible parts may be hot when the oven is used, young children should be kept away.

The main oven is a multi-function oven, and may be used as a conventional oven or a fanned oven. It may also be used as a grill, or with one of the other oven functions.

Manual operation

The programmer must be set to manual operation before the main oven or grill functions can be used. If **A** (Auto) is on the programmer display, return the oven to manual operation by pressing the plus and minus buttons simultaneously. Any programme which has been set is cancelled.

Baking tray and roasting tins

For best cooked results and even browning, the maximum size baking trays and roasting tins that should be used are as follows;

Baking tray 350mm x 280mm

This size of baking tray will hold up to 16 small cakes.

Roasting tin 370mm x 320mm

We recommend that you use good quality cookware. Poor quality trays and tins may warp when heated, leading to uneven baking results.

To turn on the main oven

Step 1 - Select the function

Turn the selector control knob in either direction, until the function you require is selected.

Step 2 - Set the main oven control

If you have selected an oven cooking function, then simply turn the main oven control knob clockwise to the required temperature - this brings on the neon indicator light, which will stay on until the oven reaches the required temperature.

If you have selected defrost, do not turn the thermostat control on.

To switch off the main oven, return the control knobs to the 'off' position.

Automatic operation

See 'Programmer / Clock' section.

USING THE MAIN OVEN

Oven cooking

Caution: Accessible parts may be hot when the appliance is in use - keep children away from the vicinity of the oven.

Never put items directly on the base of the oven or cover the oven base with foil, as this can cause the base element to overheat.

Manual operation

Set the programmer to manual operation. See 'Programmer / Clock' section.

Turn the selector control knob until the symbol for the desired oven function is selected.

Turn the main oven control knob to the desired temperature.

The red thermostat indicator neon will come on until the selected temperature is reached, then go off. It will cycle on and off as the thermostat operates to maintain the selected temperature.

To switch off the main oven, return the main oven control knob to the "off" position.

Automatic operation

See 'Programmer / Clock' section.

Oven shelves

The oven shelf must be positioned with the upstand at the rear of the oven and facing up.

Position baking trays and roasting tins on the middle of the shelves, and leave one clear shelf position between shelves, to allow for circulation of heat.

Preheating (conventional mode)

When using the conventional mode to cook sensitive items such as soufflé's and Yorkshire puddings or, when cooking bread, we recommend that the oven is pre-heated until the neon switches off for the first time. For any other types of cooking, a pre-heat is not required.

Always use the fan oven setting for preheating to save time and electricity. After the oven has been preheated on the fan oven setting, turn the selector control knob to the oven setting you require.

Preheat the oven until the indicator neon switches off for the first time; this will take between 5 - 15 minutes, depending on the temperature selected.

When using the oven

As part of the cooking process, hot air is expelled through a vent at the rear of the oven. When opening the oven door, care should be taken to avoid any possible contact with potentially hot air, since this may cause discomfort to people with sensitive skin. We recommend that you hold the underneath of the oven door handle.

The cooling fan

The cooling fan may operate when the main oven is on and may continue to operate for a period after the oven has been switched off.

USING THE MAIN OVEN

Fan oven

- (i) Turn the selector control knob to the fan oven symbol.
- (ii) Turn the temperature control knob to the required temperature.

The fan oven comes on when the oven is switched on and circulates the air around the oven to give a fairly even temperature throughout the oven.

Conventional oven

- (i) Turn the selector control knob to the conventional oven symbol.
- (ii) Turn the temperature control knob to the required temperature.

The temperature you select corresponds to the temperature in the middle of the oven.

The top heat comes from the outer element of the grill, and the base heat is under the oven base.

Top heat only

- (i) Turn the selector control knob to the top heat symbol.
- (ii) Turn the temperature control to the required temperature.

This setting can be used to brown the top of dishes such as cauliflower cheese or baked alaska etc.

Base heat only

- (i) Turn the selector control knob to the base heat symbol.
- (ii) Turn the temperature control knob to the required temperature.

This setting can be used to finish cooking pastry bases, pies or pizzas etc.

Fan and base heat only

- (i) Turn the selector control to the fan and base heat symbol.
- (ii) Turn the temperature control knob to the required temperature.

This setting can be used to finish items without a top crust - eg; jam tarts, open mince pies and flans.

Intensive bake (Pizza setting)



- (i) Turn the selector control to the intensive bake symbol.
- (ii) Turn the temperature control to the required temperature.

This setting is ideal for pizzas and also for items with a high moisture content - eg; fruit flans, quiches and cheese cake.

USING THE MAIN OVEN

Cooking with a fanned oven

As this is a high efficiency oven, you may notice the emission of steam from the oven when the door is opened. Please take care when opening the door.

If you have been used to cooking with a conventional oven, you will find a number of differences to cooking with a fanned oven, which will require a different approach:

There are no zones of heat in a fanned oven, the convection fan at the back of the oven ensures an even temperature throughout the oven. This makes it ideal for batch baking - eg; when planning a party or stocking the freezer, as all items will be cooked within the same length of time.

Foods are cooked at a lower temperature than a conventional oven, so conventional recipe temperatures may have to be reduced. Please refer to the conversion chart.

Pre-heating is generally not necessary as a fan oven warms up quickly.

There is no flavour transference in a fan oven, which means you can cook strong smelling foods such as fish at the same time as mild foods - eg; milk puddings.

When batch baking foods that will rise during cooking - eg; bread - always ensure that enough space has been left between shelves to allow for the rise.

Notes:

When 2 or more shelves are being used, it may be necessary to increase the cooking time slightly.

Because the 2 oven shelves are wider than in many ovens, it is possible to cook 2 items per shelf - eg; 2 victoria sandwiches or 2 casseroles. Although you need to keep in mind the point from the previous page 'To help the air circulate freely' with careful choice of dishes and tins, it is possible to cook a complete meal and perhaps something else for the freezer in the oven at the same time.

When roasting meats, you may notice that fat splashing is reduced, which is due in part to the lower oven temperatures, and will help keep cleaning of the oven to a minimum.

Because a fan oven has an even temperature throughout the oven, no shelf positions have been given in the following baking guide, and there is no need to interchange dishes onto different shelves part way through cooking, as with a conventional oven.

USING THE MAIN OVEN

To help the air circulate freely

- Position the shelves evenly within the oven and maintain a clearance from the oven roof and base.
- If more than one cooking dish or baking tray is to be used on a shelf, leave a gap of at least 25mm between the items themselves and the oven interior.
- Allow enough space between shelves for food that will rise during cooking.
- Do not place items on the oven base as this will prevent air from circulating freely.

Main oven baking guide

Cooking times

These times are based on cooking in a preheated oven.

The cooking times given are only approximate because the size and type of cooking dish will influence cooking time, as will personal preference.

Cooking temperatures

- The temperature settings and times given in the baking guide are based on dishes made with block margarine.
- If soft tub margarine is used it may be necessary to reduce the temperature setting.
- If a recipe gives a different temperature setting to that shown in the guide, the recipe instruction should be followed.

MAIN OVEN CONVERSION GUIDE

Note: this is a high efficiency oven, therefore some adjustment will have to be made to **conventional** cooking temperatures when using the fanned oven. The table below shows conventional cooking temperatures, fanned oven temperatures and gas marks. For optimum results, conventional temperatures need to be converted to fanned temperatures.

For example, an item which would normally cook at a conventional temperature of 180 °C, will now cook at the fanned temperature of 160°C.

Conventional temperature (°C)	Fanned Oven (°C)	Gas Mark
100	100	1/4
110	110	1/4
130	120	1/2
140	130	1
150	140	2
160	150	3
180-190	160	4-5
200	170	6
220	180	7
230	190	8
250	200	9

USING THE OVENS

Baking guide

Dish	Recommended temperature °C		Suggested shelf position (counted from bottom up)	Approximate cooking time (preheated oven)
	Fanned	Conventional		
Scones	180	220	3 & 5	8 - 15
Meringues	110	110	1	2 - 3 hrs
Cakes				
Small cakes	160	190	2 & 4	15 - 25 mins
Whisked sponge	160	190	3	15 - 20 mins
Swiss roll	170	200	3	10 - 12 mins
Victoria sandwich (2 x 180mm / 7")	160	180	3	20 - 30 mins
Genoise sponge	160	180	3	20 - 25 mins
Madeira (180mm / 7")	160	180	2	1 hr - 1¼ hrs
Semi rich fruit cake (205mm / 8")	130	150	2	2½ - 3hrs
Christmas cake (205mm / 8")	depending on recipe		2	depending on recipe
Dundee cake (205mm / 8")	130	150	2	2½ - 3hrs
Pastry				
Flaky / Puff	180	220	top - middle	depending on recipe and type of filling
Shortcrust	170	200	top - middle	
Choux	170	200	top - middle	
Plate tarts (2 x 180mm / 7")	170	200	top - middle	
Biscuits				
Shortbread rounds	160	190	top - middle	20 - 25 mins
Nut brownies	170	200	top - middle	20 - 25 mins
Brandy snaps	160	180	top - middle	10 - 12 mins
Flapjacks	160	180	top - middle	20 - 25 mins
Ginger nuts	160	180	top - middle	10 - 20 mins

USING THE MAIN OVEN

Cooling and defrosting in the main oven

To **cool** foods after cooking prior to refrigerating or freezing, turn the oven control to the defrost position, and **open** the door.

To **defrost** frozen foods, turn the oven control to the defrost position, place the food in the centre of the oven and **close** the door.

Defrosting times

Small or thin pieces of frozen fish or meat - eg; fish fillets, prawns, and mince will take approximately 1 - 2 hours. Placing the food in a single layer will reduce the thawing time.

A medium sized casserole or stew will take approximately 3 - 4 hours.

A 1½kg / 3lb oven ready chicken will take approximately 5 hours, remove the giblets as soon as possible.

Always check foods are thoroughly defrosted before cooking.

Be safe

- Do not defrost stuffed poultry using this method.
- Do not defrost larger joints of meat and poultry over 2kg / 4lb using this method.
- Never place uncooked food for defrosting next to cooked food which is to be cooled, as this can lead to cross contamination.

- Defrosting meat, poultry and fish can be accelerated using this method, but make sure they are completely thawed before cooking thoroughly.

Place meat and poultry on a trivet in a meat tin, to catch the juices from the defrosting process.

Slow cooking (Setting)

- Make sure that frozen foods are thoroughly THAWED before cooking.
- Do not slow cook joints of meat or poultry weighing more than 2½kg / 4½lb.
- Only use the fanned oven function for slow cooking.
- Preheat the oven to 170°C and cook for 30 minutes, then adjust the oven control to  (slow cook setting) for the remainder of the cooking time.
- Slow cooking times will be about 3 times as long as conventional cooking times.
- Do not open the oven door unnecessarily during slow cooking, as this will result in heat loss at low temperatures.
- Always use dishes with tightly fitting lids. To rectify badly fitting lids, place foil over the dish underneath the lid.

USING THE OVENS

Roasting guide

The times given in the roasting guide are only approximate, because the size and age of the bird will influence cooking times as will the shape of a joint and the proportion of the bone.

Frozen meat should be thoroughly thawed before cooking. For large joints it is advisable to thaw overnight.

Frozen poultry should be thoroughly thawed before cooking. The time required depends on the size of the bird - eg; a large turkey may take up to 48 hours to thaw.

Use of a trivet with a roasting tin will reduce fat splashing and will help to keep the oven interior clean. Alternatively, to help reduce fat splashing, potatoes or other vegetables can be roasted around the meat / poultry.

Notes:

- When cooking stuffed meat or poultry calculate the cooking time from the total weight of the meat plus the stuffing.
- For joints cooked in foil or covered roasters, and for lidded casseroles, add 5 minutes per 450g (1lb) to the calculated cooking time.
- Smaller joints weighing less than 1.25kg (2½lb) may require 5 minutes per 450g (1lb) extra cooking time.
- Position the oven shelf so that the meat or poultry is positioned in the centre of the oven.
- It is recommended that the appliance is cleaned after open roasting.

Cook in oven at: 160 - 180°C Main Oven Fanned 180 - 200°C - Top Oven Conventional 180 - 200°C - Main Oven Conventional		Approximate Cooking Time (preheated oven) (preheated oven)
Beef	Rare Medium Well done	20 minutes per 450g (1lb), plus 20 minutes 25 minutes per 450g (1lb), plus 20 minutes 30 minutes per 450g (1lb), plus 30 minutes
Lamb	Medium Well done	25 minutes per 450g (1lb), plus 25 minutes 30 minutes per 450g (1lb), plus 30 minutes
Pork		35 minutes per 450g (1lb), plus 35 minutes
Poultry		20 minutes per 450g (1lb), plus 20 minutes

USING THE OVENS

Traditional fruit cakes

It should be remembered that ovens can vary over time, therefore cooking times can vary, making it difficult to be precise when baking fruit cakes.

It is necessary therefore, to test the cake before removal from the oven. Use a fine warmed skewer inserted into the centre of the cake. If the skewer comes out clean, then the cake is cooked.

- Follow the temperatures recommended in the recipe and then adjust according to the conversion guide on page 14.
- Do not attempt to make Christmas cakes larger than the oven can cope with, you should allow at least 25mm (1 inch) space between the oven walls and the tin.
- To protect a very rich fruit cake during cooking, tie 2 layers of brown paper around the tin.
- We recommend that the cake tin is not stood on layers of brown paper, as this can hinder effective circulation of air.
- Do not use soft tub margarine for rich fruit cakes, unless specified in the recipe.
- Always use the correct size and shape of tin for the recipe quantities.

Roast turkey

Roasting turkey perfectly can prove difficult, as you are cooking two different types of meat - the delicate light breast meat, which must not be allowed to dry out, and the darker leg meat, which takes longer to cook.

The turkey must be roasted long enough for the legs to cook, so frequent basting is necessary. The breast meat can be covered once browned.

- Turkey should be roasted at 180°C (conventional) 160°C (fanned) for 20 minutes per 1lb, plus 20 minutes, unless packaging advises otherwise.
- The turkey can be open roasted, breast side down, for half of the cook time, and then turned over for the remainder of the cooking time.
- If the turkey is stuffed, add 5 minutes per 1lb to cook time.
- If roasting turkey covered with foil, add 5 minutes per 1lb to cook time.

To test if the turkey is cooked, push a fine skewer into the thickest part of the thigh. If the juices run clear, the turkey is cooked. If the juices are still pink, the turkey will need longer cooking.

USING THE OVENS

Automatic cooking

The automatic cooking facility is controlled by the programmer (see 'Programmer / Clock' section) and allows complete meals or individual dishes to be cooked while you are out of the house, to be ready for when you return. The 'READY TIME' should be set as close as possible to, or just after, your anticipated return, so food is not left standing in a warm oven.

Do

- Select foods which are as fresh as possible, and as cold as possible - ie; preferably straight from the refrigerator.
- Choose foods which are suitable for cooking from a cold start, as some dishes will be affected by being left uncooked, at room temperature, perhaps for several hours - eg; a wet filling on a pastry base.
- Make sure that meat and poultry are thoroughly thawed (but still cold from the refrigerator) before placing them in the oven, and avoid using rolled joints of meat, which can be more susceptible to the growth of food poisoning organisms.
- Cover dishes with lids or foil to keep the food moist, and protect from possible contamination; the food can be uncovered towards the end of cooking to crisp and brown.

Do not

- Warm food should never be placed in the oven if there is a delay period.
- Stews prepared by frying the meat and vegetables first should be cooked as soon as possible, or refrigerated prior to placing in the oven.
- Some dishes are not suitable for cooking on automatic - eg; dishes containing left over meat or poultry, dishes containing eggs, cooked rice, or seafood.
- Do not put food items (intended for automatic cooking) into a warm oven; allow the oven to cool before setting for automatic cooking.
- Do not over fill dishes containing liquids, as they might boil over.
- Never leave food in the oven to cool slowly after cooking; serve immediately or refrigerate.
- Never use the automatic facility to reheat 'cook chill' foods, as they should go straight from the refrigerator into a preheated oven.

USING THE OVENS

Important:

Food is more susceptible to the growth of food poisoning organisms in warm conditions. If the weather is hot, either take care to ensure that food is not left standing in a warm oven, or avoid using the automatic cooking facility.

Hints for automatic cooking

- Food is placed in a cold oven so you will need to add about 10 - 15 minutes onto the cooking time to allow for the oven to reach the selected temperature.
- Wine or beer may ferment, and cream may curdle during the delay period, so it is best to add these ingredients just before serving.
- Potatoes should be parboiled or brushed with oil to prevent discolouration during the delay period.
- Meat can be brushed with oil to prevent it drying.
- Lemon juice can be added to certain fruits and vegetables such as apples, pears, turnips and parsnips to prevent discolouration during the delay period.

PROGRAMMER / CLOCK

Automatic cooking is only available in the main oven.

The programmer buttons

∇ down - reduce

▲ up - increase

The 'function' button in the centre is used for setting the minute minder and setting up the automatic cooking. See below for details.

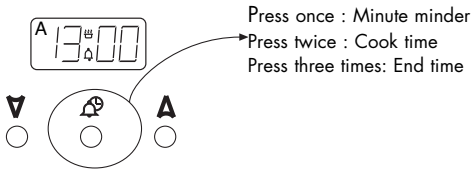

Symbols on the LED display.

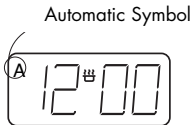

This 'A' symbol appears when either a semi, or fully automatic program is selected. This symbol will flash while a program is being set. Once a program is set the symbol will light up, and remain lit until the alarm sounds, or the program is cancelled

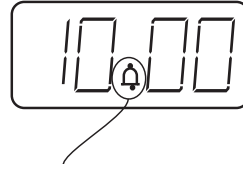

Minute Minder Symbol

This Bell symbol appears when the Minute Minder function has been selected. While the Minute Minder is being set, the Bell symbol flashes. Once the length of time is set, the Bell symbol remains lit until the time runs down, or the function is cancelled.



This message and 'A' symbol appear when you are asked to set the length of time you require the oven to cook automatically for. Using the Up and Down buttons adjusts this accordingly.



This message and 'A' symbol appear when you are asked to enter in an end time, or when you would like the oven to switch itself off.

PROGRAMMER / CLOCK

To set the time of day

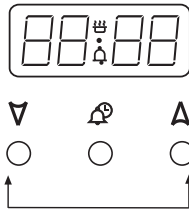

- ◆ Press the Up and Down buttons together for a few seconds, and release.
- ◆ The '●' in between the numbers on the LED Display will begin to flash.
- ◆ While the '●' is flashing it is possible to adjust the time using the Up and Down buttons. Once the time has been set, allow approximately 30 seconds before using any of the other timer functions. This ensures that the time will remain correct.

To select an alarm tone

There are three tones to chose from.

- ◆ Press and hold the *down* button to listen to the first tone.
- ◆ Release the *down* button and press it again to listen to the second tone etc.
- ◆ Releasing the *down* button after the tone has sounded will automatically select that tone

Setting the minute minder

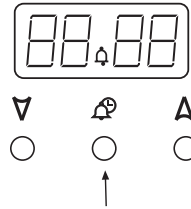

- ◆ To set the Minute Minder, press the Function button once. The bell symbol will appear and start flashing. The flashing only lasts for 5 seconds so the time must be set within this time frame.
- ◆ Use the Up and Down button to set the length of time required. Once this has been done, the Minute Minder is set.
- ◆ When the desired length of time has counted down the alarm will sound.
- ◆ To cancel the tone, press any of the buttons.
- ◆ To cancel the Minute Minder at any time, press the Up and Down buttons together.

PROGRAMMER / CLOCK

Semi-automatic cooking

There are two types of semi automatic cooking available on this appliance.

The oven must be switched on, and in use to use either of these functions successfully.

The Duration method allows you to set the oven for a specific length of time. If a dish needed 2 hours to cook, then it would be possible for you to set the oven to turn off 2 hours later. This allows you to be sure that your food will be cooked for a set length of time and no longer.

The End Time method allows you to enter a specific time when you would like the oven to switch off. If you wish to leave the oven unattended, then it offers peace of mind that the oven will have turned itself off at the set time.

However, once the program is set then it cannot be adjusted. Extra time cannot be added, nor can the end time be extended.

To cancel the semi automatic programs, press both the Plus and Minus buttons together. This can be done at any time during the cooking process. Then if necessary, re program.

For the instructions on how to use both of these functions, please see the following page.

Fully automatic cooking

This function incorporates both a duration and an end time and is meant to be used when you wish to delay the start time.

We recommend that the first few times this function is used you are in the house, this will familiarise you with your oven and prevents food from being over cooked or under cooked.

Care must be taken when selecting foods for this function, it is not recommended for certain food items which may spoil, or are sensitive to being left.

It is also advisable to set the end time to be as close to your return as possible to prevent food being left standing.

PROGRAMMER / CLOCK

Semi-automatic cooking

The Duration method

- ◆ Press the Function button twice, **(1)** which will skip past the Minute Minder.
- ◆ The LED display will flash the word 'dur', **(2)** and the 'A' will flash on the left hand side of the display.
- ◆ Use the Plus and Minus buttons to set the length of time you want to cook for. **(3)** This must be done within 5 seconds or the time of day will show again.

Once this is done the oven will automatically switch off once the time has elapsed, and the alarm will sound. To switch off the alarm, press any button. To view any remaining time press the function button twice

The End Time method

- ◆ Press the Function button three times, which will skip past the Minute Minder and the Duration programmer. **(4)**
- ◆ The LED display will flash the word 'End' and the 'A' will flash on the left hand side of the display. **(5)**
- ◆ Use the Plus and Minus buttons to select the time the oven is required to turn off. **(6)**

Once this is done the oven will turn itself off at the time you have selected. To switch off the alarm, press any button.

1. The Duration method

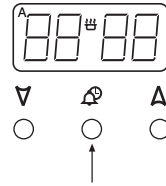

2.



3.

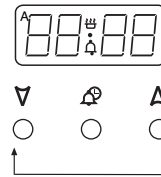

4. The End Time method

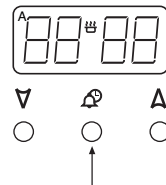

5.

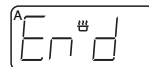

6.

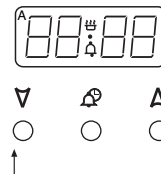

PROGRAMMER / CLOCK

Fully automatic cooking (example)

This programming method is best suited for when a delayed start time is required. Unlike the semi automatic methods this requires both the duration and the end time to be entered. The timer will work out the start time and begin cooking.

◆ Press the function button twice to select the length of time your food will need. **(7)**

◆ The 'A' on the left hand side will flash and the 'dur' message will flash up. **(8)**

◆ Using the Plus and Minus buttons set the time you require within 5 seconds of the 'dur' message. **(9)**

◆ Press the function button three times until the 'A' flashes again and the 'End' messages appears. **(10) & (11)**

◆ Using the Plus and Minus buttons, set the time you would like the oven to switch off. **(12)**

◆ Set the temperature of the oven and place the food inside.

While the automatic function is running, the 'A' will appear statically on the display, with the time.

Try to keep the end time as close to when you expect to return, this will prevent cooked food from being left standing in a warm oven.

The timer will calculate the appropriate start time.

To switch off the alarm, press any button

7

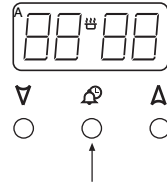

8



9

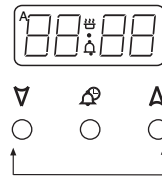

10

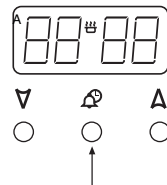

11



12

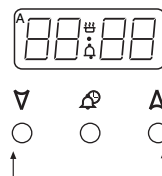

CARE & CLEANING

Caution: Any cleaning agent used incorrectly may damage the appliance.

Always let the appliance cool before cleaning.

Do not use a steam cleaner on this appliance.

Some cooking operations generate considerable amount of grease, this combined with spillage can become a hazard if allowed to accumulate on the appliance through lack of cleaning. In extreme cases this may amount to misuse of the appliance and could invalidate your guarantee.

It is recommended that the appliance is cleaned after open roasting.

Do not use caustic, corrosive or abrasive cleaning products, products containing bleach, coarse wire wool or any hard implements, as they will damage the surfaces.

All parts of the appliance can be safely cleaned with a cloth wrung out in hot soapy water.

Vitreous enamel parts

GRILL PAN, TOP OVEN / GRILL COMPARTMENT,
MAIN OVEN COMPARTMENT

Use a mild cream cleaner - eg; "Cif".

Look for one which has the Vitreous Enamel Development Council's recommendation seal.

Stubborn marks may be removed with a moistened "Brillo" pad.

The grill pan may be cleaned in a

dishwasher, or with a nylon brush in hot soapy water.

Do not use undiluted bleaches, products containing chlorides, wire wool or abrasive cleaners on aluminium, stainless steel, or plastic / painted parts as they can damage the appliance. Nylon pads can also be unsuitable.

Glass Door Panels

For your safety, glass door panels are made of toughened glass. This ensures that, in the unlikely event that a panel breaks, it does so into small fragments to minimise the risk of injury.

Please take care when handling, using or cleaning all glass panels, as any damage to the surfaces or edges may result in the glass breaking without warning or apparent cause at a later date.

Should any glass be damaged, we strongly recommend that it is replaced immediately.

CARE & CLEANING

Glass parts

FACIA PANEL, DOOR PANELS

Use a mild cream cleaner - eg; "Cif". Rinse thoroughly and dry with a soft cloth.

Important: The inner door glass panel(s) can be removed for cleaning, but they must be replaced the right way (so the reflective side faces inwards) and also pushed fully in to the stop position. To remove the glass panel, open the door wide, hold the edges of the glass and slide out.

Painted, plastic and metal finish parts (if fitted)

CONTROL KNOBS, DOOR HANDLES

Only use a clean cloth wrung out in hot soapy water.

Chrome plated parts

OVEN SHELVES & OVEN SHELF RUNNERS, GRILL PAN TRIVET

Do not use abrasives or polishes, use a moist soap pad - eg; "Brillo".

Note: Oven shelf runners can be removed for cleaning. Grasp the runners, and slide out of the hanging holes as shown.

Note: These items may also be cleaned in a dishwasher.

Stainless Steel surfaces (stainless steel finish models only)

HANDLES, DOOR PANELS

Only use a clean cloth wrung out in hot soapy water, and dry with a soft cloth.

Do not use undiluted bleach or any products containing chlorides as they can permanently damage the steel.

Extra care should be taken when cooking food in salted water. Some foods are corrosive - eg; vinegar, fruit juices and especially **salt** - they can mark or damage stainless steel if they are left on the surface. Turn off and wipe any spillage immediately, taking care to avoid skin contact with any hot surface or spillage.

Sharp objects can mark the surface of stainless steel, but marks will become less noticeable with time.

To maintain the finish of the stainless steel, or to remove any greasy marks, wipe the stainless steel surface sparingly with a *minimum* amount of Baby Oil and kitchen paper.

Do not use cooking oils, as these may contain salt, which can damage the stainless steel surface.

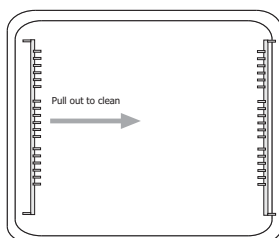

CARE & CLEANING

Cleaning the hob

Ceramic glass surface

Do not use abrasive powder cleaners, "Brillo" pads, metal wire, detergents, bleaches, bath stain removers, or chemical oven cleaners; all these product types will damage the ceramic glass.

The following recommendations will help to keep the ceramic glass surface bright and clean.

Allow the hob to cool.

Use a dampened paper towel or clean damp cloth to apply a small dab of cleaner conditioner to clean each heating area.

Use another paper towel or a clean dry soft cloth to wipe dry, and then polish the whole glass surface.

To remove any stubborn marks or heavy soiling, a non scratching, mild cream cleaner may be used - eg; "Cif".

Important: If you use a wet paper towel or clean damp cloth to remove spillage from a warm heating area of the hob, be careful to avoid steam burns.

Care and maintenance

Before using the hob for the first time, apply a thin coating of cleaner conditioner (eg; "Hob Brite", by Homecare*) to the ceramic glass only, and polish the surface with a clean cloth.

The conditioner gives a protective covering to the ceramic glass which not only makes the hob easier to clean, but also ensures that you will

gain maximum life out of this product. Occasional use will help prevent the build up of mineral deposits which can cause discolouration of the hob surface.

Discolouration of the hob

Do not use a dishcloth or dish sponge to wipe the hob - this can leave a film of detergent on the surface which will discolour the hob next time a heating area is used. Clean cloths kept for the cleaning of the hob can be used.

Do not use too much cleaner conditioner - only a thin coating is required, any excess may burn on and discolour the hob when it is next in use.

If persistent stains or marks remain on the ceramic glass surface, it can be cleaned using a mild cream cleaner - eg; "Cif", or a ceramic hob scraper. This will also remove any accumulated salts or minerals before they have an opportunity to discolour the ceramic glass.

Wipe clean with a damp paper towel or clean damp cloth and re-apply cleaner conditioner.

INSTALLATION INSTRUCTIONS

Whilst every care is taken to eliminate burrs and raw edges from this product, please take care when handling - we recommend the use of protective gloves during installation.

Moving the cooker

Please note that the weight of this appliance is approximately **60kg** (unpacked). Take care if the appliance needs to be lifted during installation - always use an appropriate method of lifting.

Do not attempt to move the cooker by pulling on the doors or handles. Open the door and grasp the frame of the cooker, taking care that the door does not shut on your fingers.

Take care to avoid damage to soft or uneven floor coverings when moving the appliance. Some cushioned vinyl floor coverings may not be designed to withstand sliding appliances without marking or damage.

Important: Ensure that you route all mains cables well clear of any adjacent heat source.

WARNING - This appliance is unsuitable for use in a marine environment.

If the appliance is placed on a base, measures have to be taken to prevent it slipping from the base.

Clearances

This cooker may be fitted flush to base units. However, for models with side opening doors, we recommend a side clearance of 60mm between the cooker and any side wall to allow the door to be opened fully.

The cooker should not be placed on a base.

No shelf or overhang or cooker hood shall be closer than a minimum of 650mm, but check with cooker hood manufacturer's recommendations.

The cooker must have a side clearance above hob level of 90mm up to a height of 400mm.

Dimensions

All sizes are nominal, and some variation is to be expected. The 'depth' of the cooker, as given below, is to the front of the door and excluding knobs and handles.

Width: 600mm

Depth: 600mm

Height (adjustable): 900 - 930mm

Levelling the cooker

Turn the feet by hand to adjust the height of the cooker.

INSTALLATION INSTRUCTIONS

Fixing and Securing

Your cooker may be secured to a wall or a solid partition behind the cooker using the fixing bracket supplied, or to the floor or adjacent cabinets using the method described on the next page.

Levelling

Once your cooker is secure:

Place a spirit level onto a baking tray, on an oven shelf.

These cookers are fitted with adjustable feet which will allow you to adjust the height of the appliance until it is level. The adjustable feet are at the front and rear of the cooker.

This appliance "must be" fixed at the rear using the bracket provided

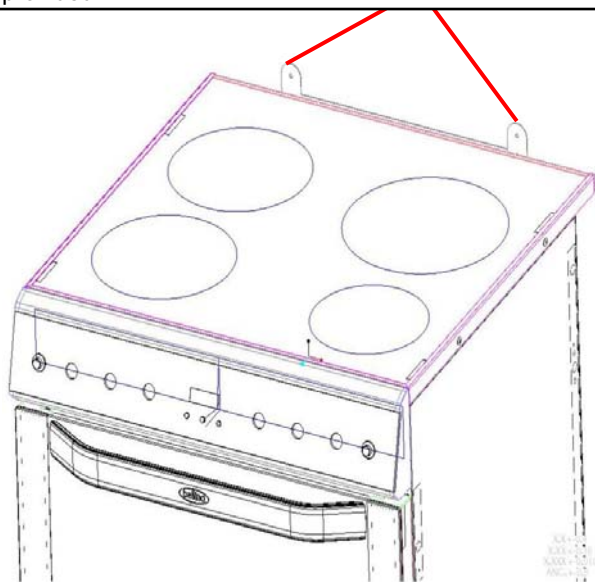

WARNING: IN ORDER TO PREVENT TIPPING OF THE APPLIANCE, EITHER THIS STABILISING MEANS OR THE STABILISING BRACKET SUPPLIED MUST BE INSTALLED.

Anti-Tilt Device

This cooker is supplied with anti-tilting chains and anti-tilting bracket to prevent accidental tilting of the cooker. To fit the bracket, please refer to the instruction manual supplied with your cooker. To fit the chains, please install as follows:

- Remove the two screws located on the rear panel, approximately 500mm above the floor.
- Fix each chain to the cooker with the screws.
- Fix each chain to the floor or the wall with suitable fasteners which suit the floor/wall material and easily restrains the weight of the cooker.

WARNING: In order to prevent accidental tipping of the appliance, for example by a child climbing onto the open oven door, the stabilising means must be installed. The chains and bracket are a safety device and either must be fitted to all cookers. Failure to fit the chains or bracket properly may cause personal burn injuries and damage to the appliance.

If the chains cannot be fitted because the appliance is between two cupboards, please drill a hole on each side of the cupboards, pass the chains through the holes and anchor the chains within each cupboard.

Important: After fixing the chains ensure the chains are taut and the cooker does not tilt forward or sideways.

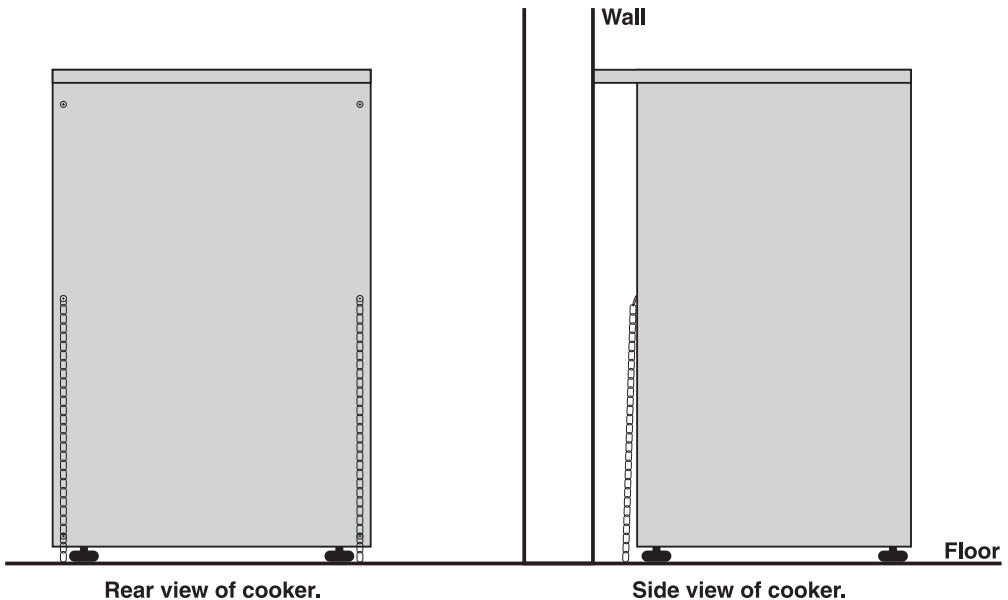

INSTALLATION INSTRUCTIONS

Connect to the electricity supply

Warning: This appliance must be earthed.

The appliance must be installed by a competent electrician using a double pole control unit of 32 ampere minimum capacity with 3mm minimum contact separation at all poles.

We recommend that the appliance is connected by a competent person who is a member of a recognised 'competent persons scheme' and who will comply with local regulations.

1. Access to the mains terminal is gained by opening the terminal block cover at the rear of the appliance (use a small flat-bladed screwdriver).
2. Connection should be made with 6.0mm² flexible twin and earth cable.
3. First strip the wires, then push the cable through the cable clamp in the terminal block cover.
4. Connect the cable to the terminal block using an 8mm socket and tighten the cable clamp screw (see diagram).
5. Close the terminal box, ensuring that the cover is engaged on the locking tabs.
6. Sufficient cable should be use to allow the cooker to be pulled out, but must hang clear of the floor so it does not become twisted or trapped when the cooker is pushed back.

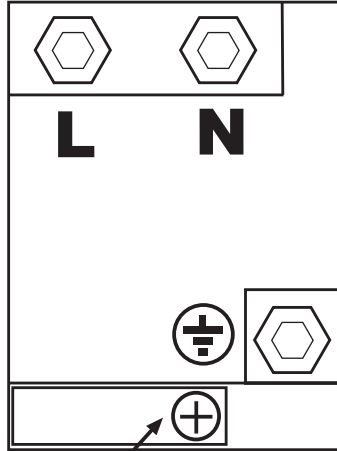

Cable Clamp

TECHNICAL DATA

Electrical supply/Load

240V ~ 50Hz

12455 W

Warning: This appliance must be earthed.

Dimensions

All sizes are nominal so some variation is to be expected.

Height (adjustable) 895 - 930mm

Width 600mm

Depth (not including handle) 600mm

Databadge is located at the bottom of the front frame, behind the door. 7

Countries of destination

AUS & NZ

Wiring colour code: Bk - Black, Bn - Brown, Bu - Blue, Gn - Green, Or - Orange, R - Red, W - White, Y - Yellow, P - Pink.

Mains Voltage Wiring Diagram for Induction Hob

Main Oven And Top Cavity Wiring

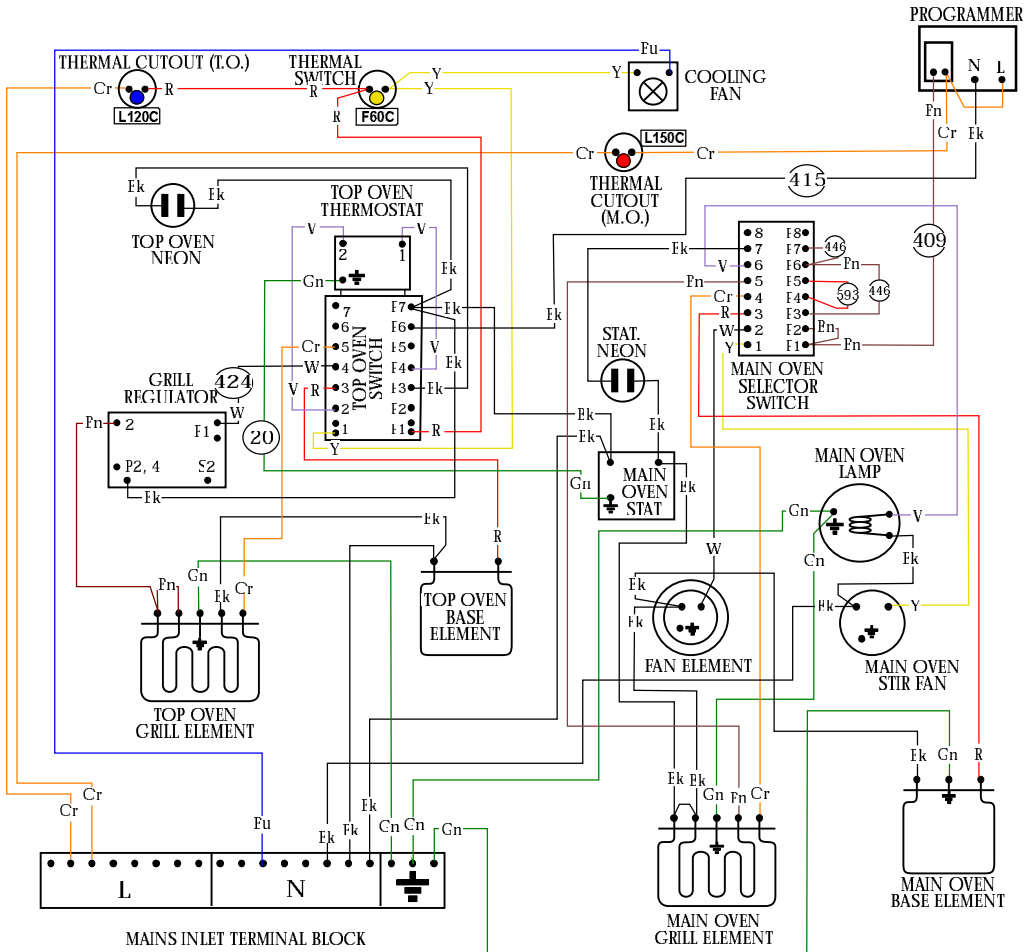

Wiring colour code: Bk - Black, Bn - Brown, Bu - Blue, Gn - Green, Or - Orange, R - Red, W - White, Y - Yellow, P - Pink.

Mains Voltage Wiring Diagram for Induction Hob

Induction Hob Wiring

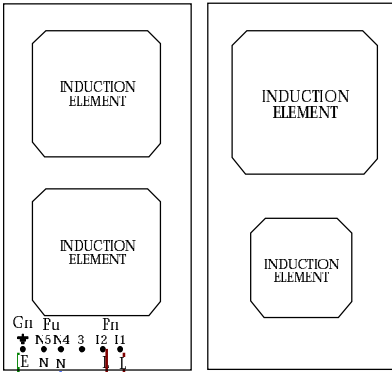

LinBUS Connections

Encoder Connections

Control Board Connection

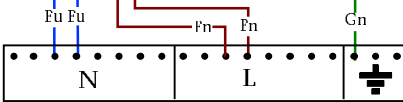
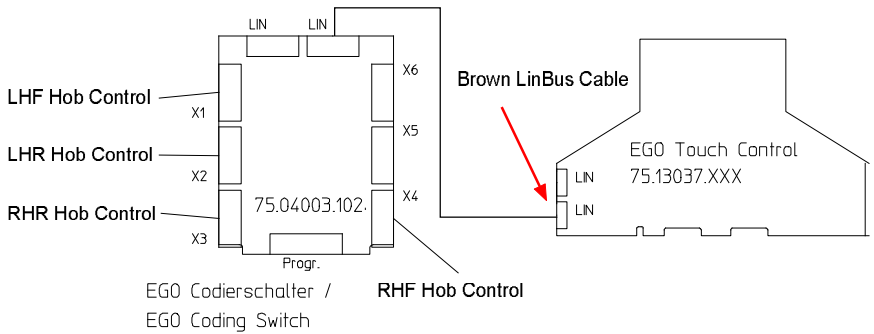

MAINS INLET TERMINAL BLOCK

Contact Us

Calling for a service

If you should experience any problems with your cooker please contact your retailer or place of purchase.

Important note:

Service work is to be conducted by authorised persons only. It is also advisable that your cooker is checked regularly and maintained in good condition. An annual maintenance is recommended.

Always check the instruction book before calling a service agent to make sure you have not missed anything.

Glen Dimplex Australia Pty Ltd Customer Care:

Tel: Australia 1-300-556-816
New Zealand 09-274-8265

Before you contact a service agent, make sure that you have the following information to hand:

Model Number
Serial Number
Date of Purchase
Postcode



Glen Dimplex Australia Pty Ltd, Unit 2, 205 Abbots Road, Dandenong,
South Victoria 3175, Australia
e-mail: sales@glendimplex.com.au
web: www.glendimplex.com.au

08 27467 02 © 02.2010

Model Names: Belling FSE 60 I-AU

PRODUCT: BEL FSE 60 I AU Sta
 COLOUR: Stainless Steel
 CODE: 444440228
 ISSUE:
 DATE:

FREESTANDING



Key	Product	Product Description	TCO	Replace	Date	Qty
	073103216	CHASSIS fs 60 e tc ind				1
00358	602925404	FRONTFRAME 60 std mot				1
00783	082360801	SLEEVE silicone (black)				1
0211	082291500	COVER flue vent				1
0314	082233400	FAN cooling DP203A-2123LST-C31				1
0349	081830501	FOOT levelling long				4
0599	503037200	PANEL INTER top 60ind				1
0697	562044130	PLINTH 60 blk				1
0701	082569400	PLUG hole blanking 14.7mm				1
0880	081545401	SWITCH thermal2455R/82/713F60				1
0880	082914200	SWITCH thermal cutout L120C				1
	073103401	MAIN OVEN fs 60 e mf light				1
0108	081586001	BUSH cavity support				2
0210	602598709	FANCOVER 60 flue lamp mot				1
0287	082971202	Element grill 20.35735.000				1
0293	082971800	Element base 20.35726.000				1
0294	082971302	ELEMENT oven fan 20.35719.010				1
0315	081581800	FAN oven circulation				1
0544	926016900	LAMP assy oven				1
0728	080180676	SCREW m6x30 pp mc				2
0734	081797200	SEAL main ov 550HL KB				1.6
0791	082554300	SPACER oven fan				3
0878	081702700	SWITCH selector 42.00000.002				1
0880	081545403	SWITCH thermal cut-out 150c				1
0912	082558001	THERMOSTAT EGO 55.17069.090				1
	073103601	TOP OVEN fs 60 e vg				1
0108	081586001	BUSH cavity support				2
0287	082971200	Element gr/dual 20.35715.000				1
0293	082971801	Element base 20.35727.000				1
0467	082852401	HOLDER phial				1
0508	082972400	INSULATION top oven back				1
0511	083000500	INSULATION top oven elec 12mm				1
0705	082590800	REGULATOR energy MP V01SV				1
0728	080180676	SCREW m6x30 pp mc				2
0734	081797200	SEAL main ov 550HL KB				1.2
0876	083010000	SWITCH t/ov 42.03000.029				1
0912	082558001	THERMOSTAT EGO 55.17069.090				1
	073103802	HOB MECH 60 e ind				1
0124	083009301	CABLE linbus 4 core 500mm long				1
0436	083006500	CABLE linbus 5 core				4
	083080700	Filter Board				
	083080800	Power Board				
	083081000	Fan				
	083081100	Inductor 145/180mm				
	083081200	Inductor 180/150mm				
	083081300	Inductor 210/100mm				
	083081500	User Interface				
	083081700	Lin Cable 400mm				
	083081800	Lin Cable 265mm				1
0620	083006400	PCB encoder 75.04003.102				1
0706	083006300	ENCODER 44.02020.000/01				4
	073104001	MAIN DOOR MECH fs 60				1
0147	082533800	CATCH roller (nylon)				1
0392	083001000	GLASS inner fs 60 main				1
0458	082979700	HINGE bottom door				1
0459	082979701	HINGE top door				1
0738	080180734	SCREW m4x12 tt pck ch blk				4
0823	082494402	STRIKER door (silver)				1
	073104201	TOP DOOR MECH fs 60 do				1
00455	082905901	HINGE drop down door (Zan)				2
0392	083001001	GLASS inner fs 60 top				1

PRODUCT: BEL FSE 60 I AU Sta
 COLOUR: Stainless Steel
 CODE: 444440228
 ISSUE:
 DATE:

FREESTANDING



Key	Product	Product Description	TCO	Replace	Date	Qty
0738	080180734	SCREW m4x12 tt pcsk ch blk				2
0835	082963200	Counter support				2
	073104409	FURNITURE MAIN 60 stop				1
0182	082101600	CLIP tubular				2
0420	082917304	GUIDE shelf large lh 1978				1
0421	082917305	GUIDE shelf large rh 1979				1
0749	082917403	SHELF main oven 452 wide 1970				2
	073104607	FURNITURE TOP 60 stop				1
0182	082101600	CLIP tubular				2
0411	602517700	GRILLPAN std mot				1
0420	082917300	GUIDE shelf small lh 1974				1
0421	082917301	GUIDE shelf small rh 1975				1
0427	082283705	HANDLE grill pan 1041				1
0749	082917403	SHELF main oven 452 wide 1970				1
0967	082518800	WIRE TRIVET grill pan 1130				1
	073104800	FACIA MECH fs 60 ang mf prog				1
0545	082964901	LENS neon				2
0574	082964900	NEON lamp assembly				2
0871	082423502	SUPPORT neon indicator				2
0917	082998700	TIMER LED143/ESK1351-018				1
NR	073105002	HOB AES 60 e ind blk				1
0472	012929413	Hotplate glass assy 60 ind blk				1
0472	012929414	HOTPLATE glass assy 60 ind blk				1
	073105501	MAIN DOOR AES fs 60 be Sta				1
0057	083006000	BRACKET door handle				2
0247	013009702	DOOR assy 60 main be sta				1
0303	082557900	END CAP LH door ext Blk				1
0304	082557901	END CAP RH door ext Blk				1
0428	562989812	HANDLE door be 60 sta				1
	073106001	TOP DOOR AES fs 60 be do sta				1
0057	083006000	BRACKET door handle				2
0256	013009602	DOOR assy 60 top be sta				1
0303	082557900	END CAP LH door ext Blk				1
0304	082557901	END CAP RH door ext Blk				1
0428	702989812	HANDLE door be 60 sta				1
	073106509	FACIA AES fs be 60mf ind Blk				1
0113	082588500	BUTTON timer				3
0299	083003102	ENDCAP facia lh matt black				1
0299	083003103	ENDCAP facia rh matt black				1
0322	013009509	FACIA assy be 60 fse blk				1
0525	083000906	KNOB con fs elec be Blk/Chr				8
0810	083005100	STEM timer button				3
	073107500	SIDE PANELS blk				1
	561776724	Outerside Blk				2
	073107668	LABELS be fse 60 i au				1
0424	082746702	HANDBOOK bel fse 60 i au				1
0684	563063900	PLATE appliance fixing blk				1
	073107016	WIRING fs e ind				1
0436	083031200	HARNESS induction unit				1

FREESTANDING TOP OVEN CAVITY

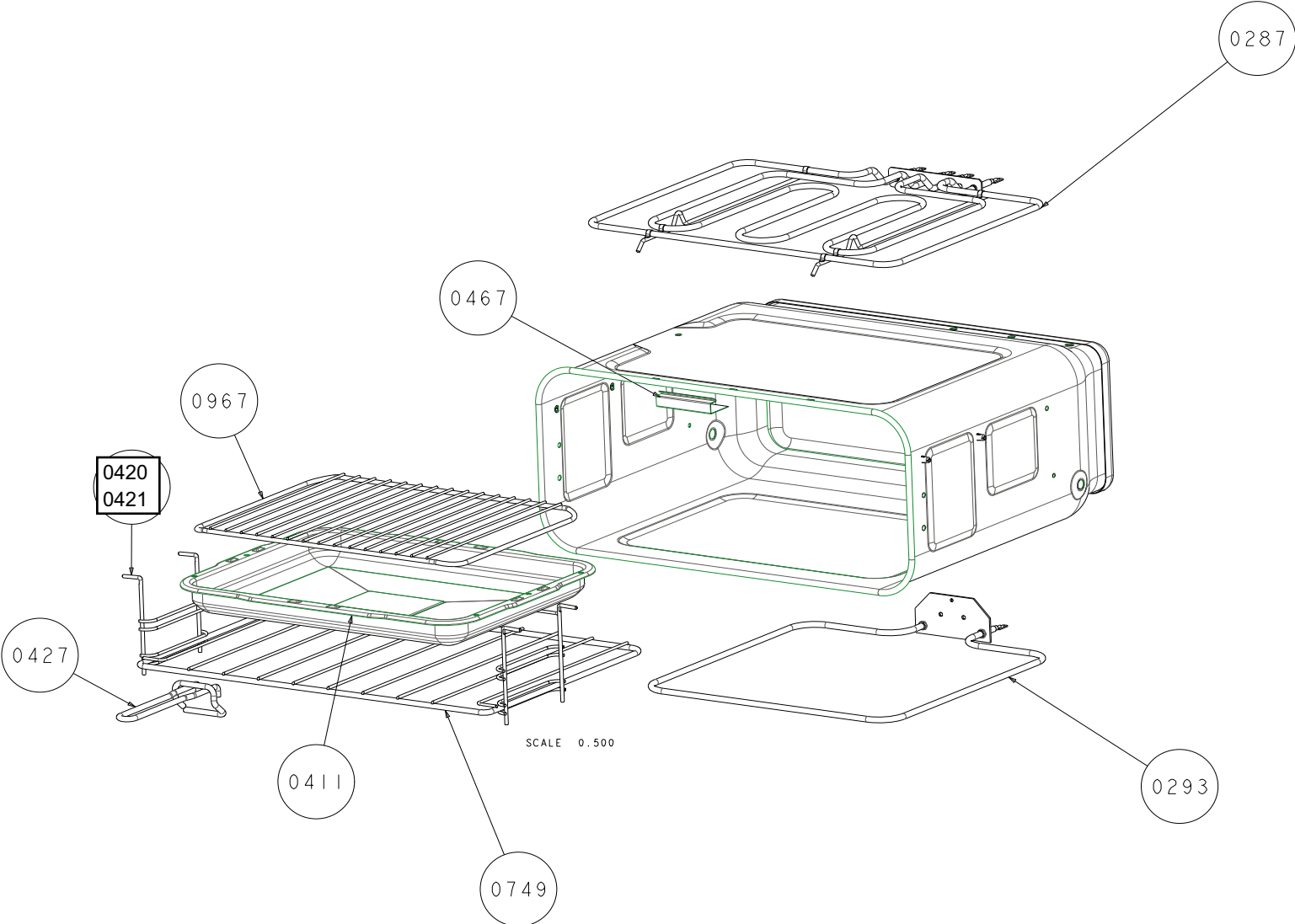

FREESTANDING MAIN OVEN ELECTRIC

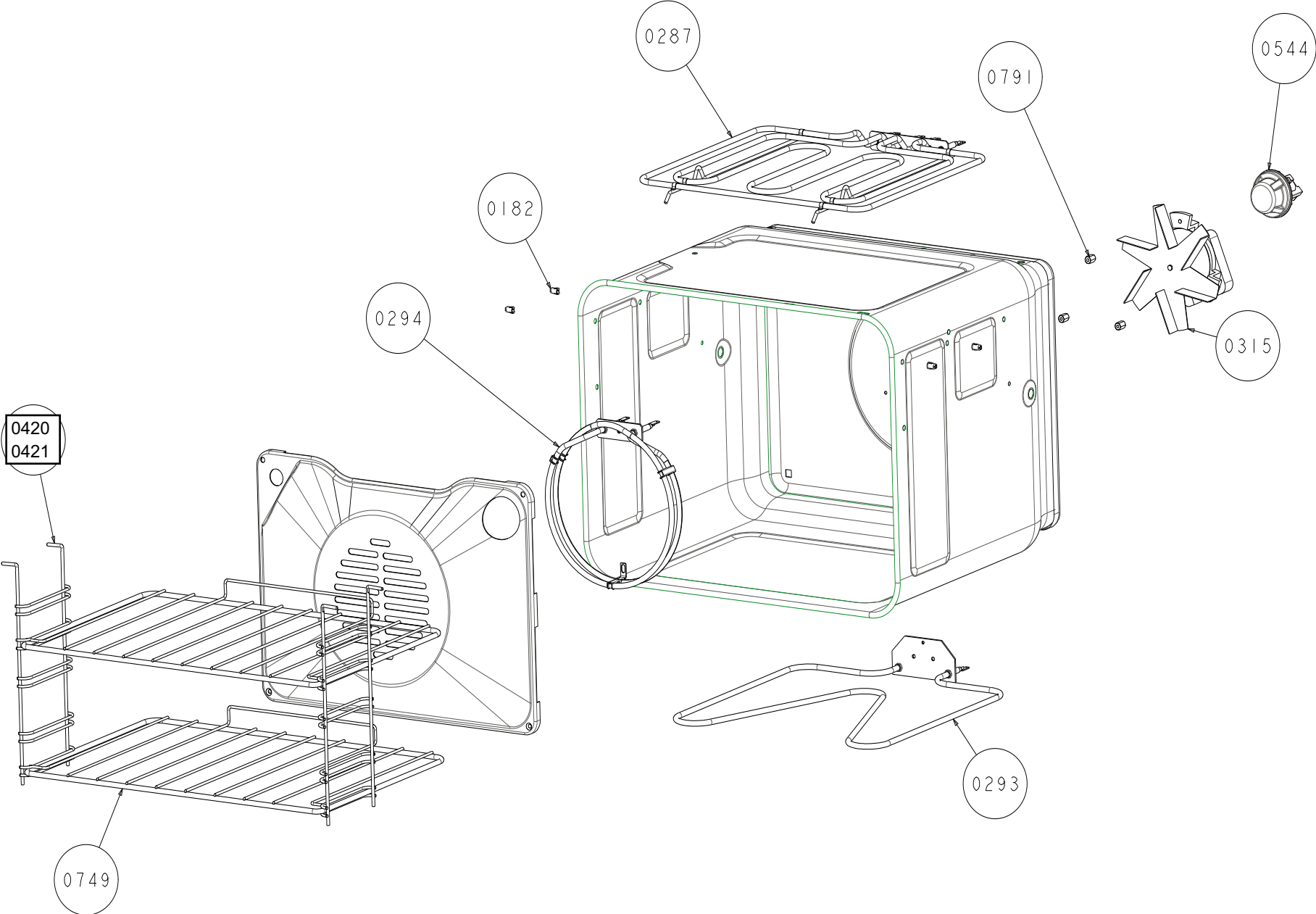

FREESTANDING ELECTRIC HOTPLATE

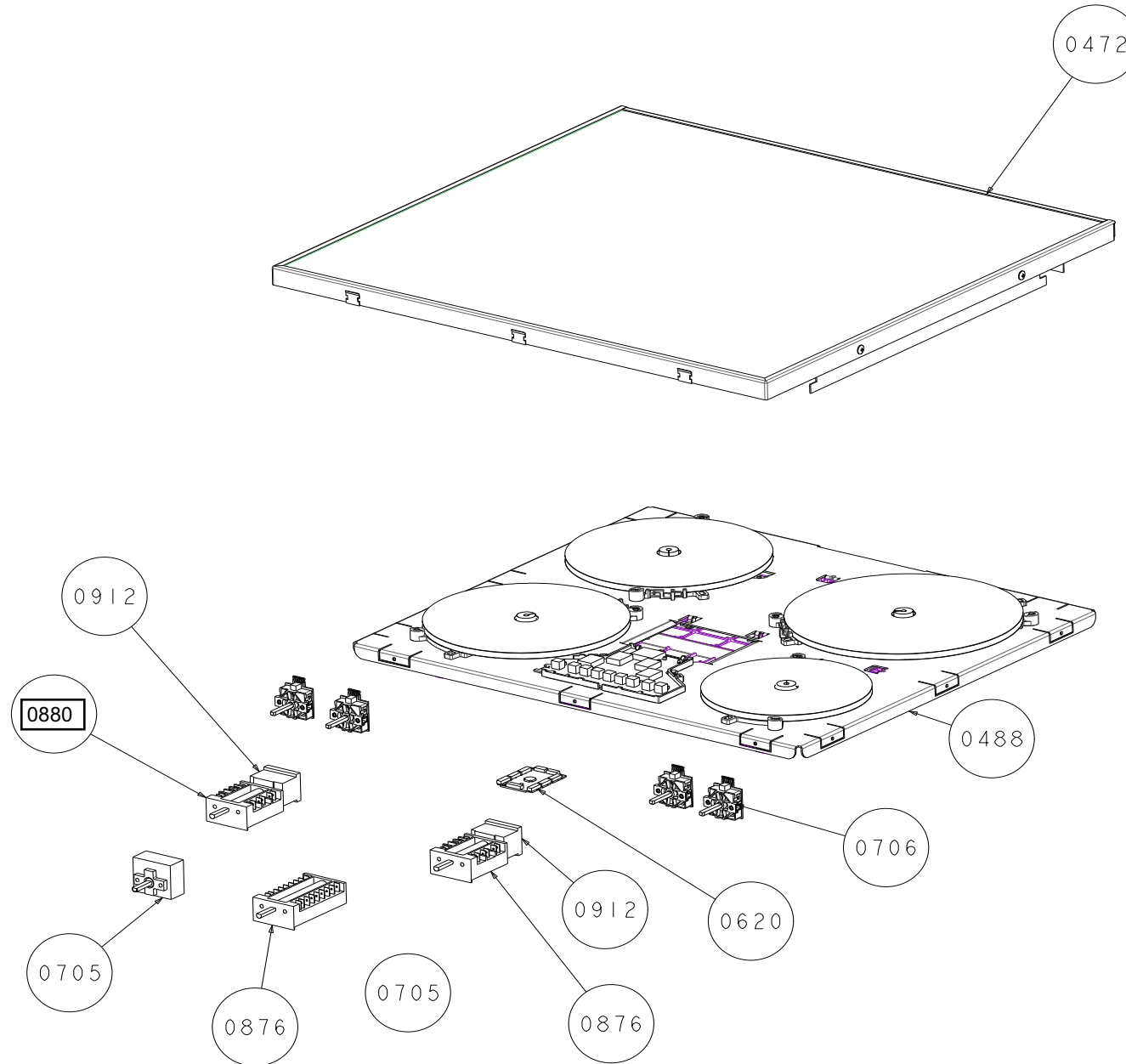



**GLEN DIMPLEX
AUSTRALIA PTY LTD**

BELLING

FSE 60 I

**REPAIR
AND
MAINTAINANCE**

PROCEDURES



IMPORTANT

**BEFORE CARRYING
OUT ANY SERVICING
WORK ALWAYS
DISCONNECT FROM
THE ELECTRICAL
SUPPLY**

1) REMOVING THE MAIN OVEN DOOR



REMOVE THE 2 SCREWS FROM THE LOWER HINGE AS INDICATED.
 REMOVE THE LOWER HINGE AND SLIDE THE DOOR DOWNWARDS AWAY FROM THE TOP HINGE
 ENSURE THAT THE DOOR IS SUPPORTED AT ALL TIMES

2) REMOVING THE TOP OVEN DOOR



OPEN THE DOOR FULLY
 RELEASE THE 2 CLIPS AND PUSH FULLY BACK INTO POSITION SHOWN
 CLOSE DOOR TO REST POSITION AND LIFT TO REMOVE DOOR AND HINGE
 WHEN REPLACING ENSURE THAT HINGES ARE FULLY ENGAGED IN THE HINGE BUSH

REMOVING THE HINGE FROM THE DOOR

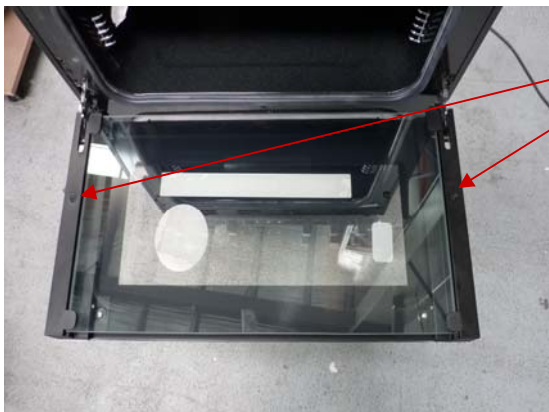

REMOVE THE 2 SCREWS AS
INDICATED
PULL THE HINGE OUT OF THE
DOOR EXTRUSION

4) REMOVAL OF SIDE PANELS



REMOVE 2X SCREWS AT REAR OF APPLIANCE

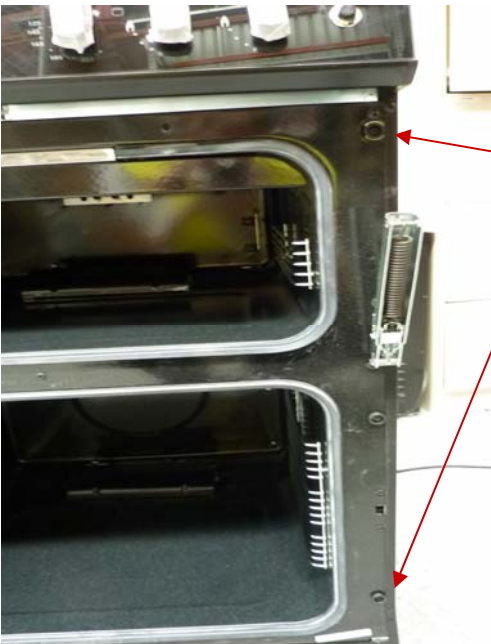

REMOVE 2X SCREWS FROM FRONT OF APPLIANCE

REMOVE SIDE PANEL

5) REMOVAL OF FACIA PANEL

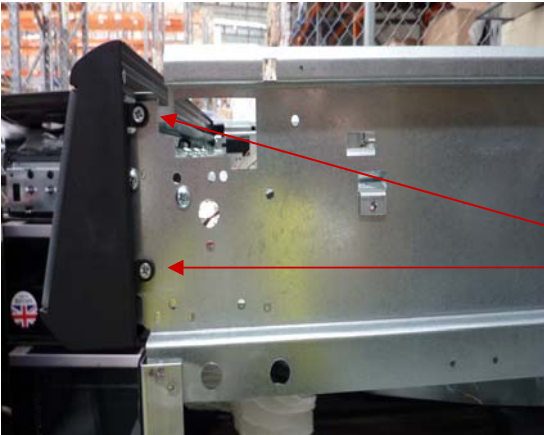

CARRY OUT BOTH OPERATIONS IN STEP 5 (REMOVAL OF SIDE PANELS)

REMOVE ALL CONTROL KNOBS

REMOVE 4 X HOLDING SCREWS 2 ON EACH SIDE

AND REMOVE THE FACIA PANEL

6) REMOVING THE REAR SERVICE PANEL

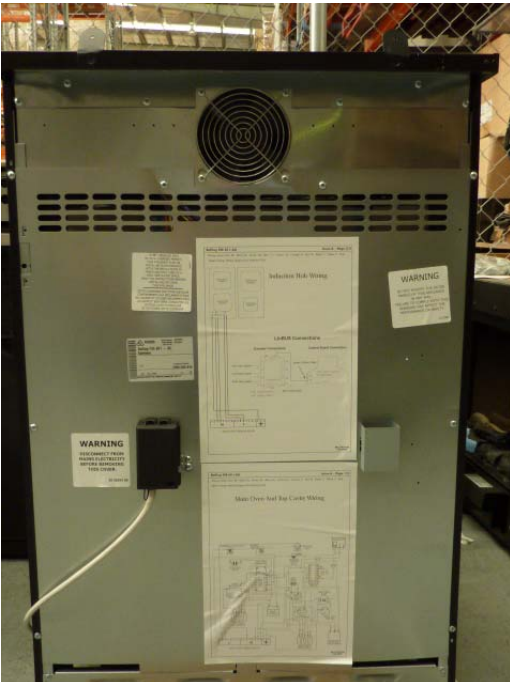

REMOVE SECURING SCREWS X6

REMOVE REAR SERVICE PANEL WITH CARE SO AS NOT TO DISCONNECT ANY OF THE WIRES CONNECTED TO THE TERMINAL BLOCK

REAR SERVICE PANEL REMOVED

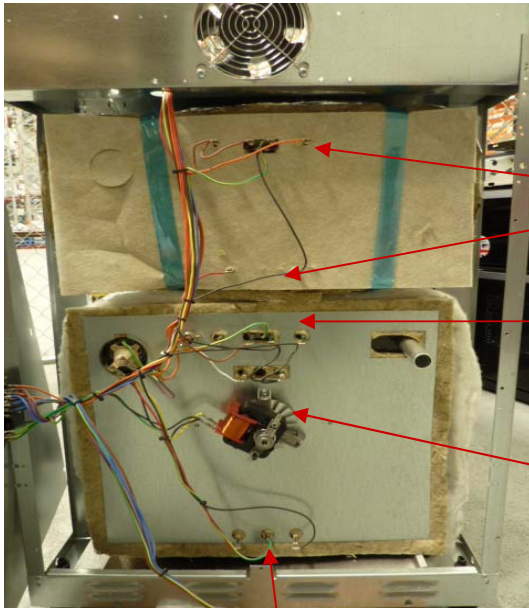

TOP OVEN GRILL ELEMENT
TOP OVEN LWR ELEMENT

MAIN OVEN GRILL ELEMENT

MAIN OVEN STIR FAN
AND ELEMENT

MAIN OVEN LOWER
ELEMENT

7) DOOR SEALS



THE DOOR SEAL IS REMOVED BY JUST PULLING IT IS SECURED IN THE GAP BETWEEN THE CAVITY AND FRONFRAME AND REQUIRES NO OTHER FIXING

TO REFIT PUSH IN ALWAYS ENSURE THAT DOOR SEAL LIP IS FACING CORRECT WAY

7) REMOVAL OF HOB ASSEMBLY



REMOVE 4 X SCREWS AS SHOWN

FROM THE FRONT OF THE HOB PUSH THE HOB BACK SLIGHTLY AND LIFT (ENSURE THAT THE ENAMAL AT THE REAR IS PROTECTED BEFORE LIFTING)

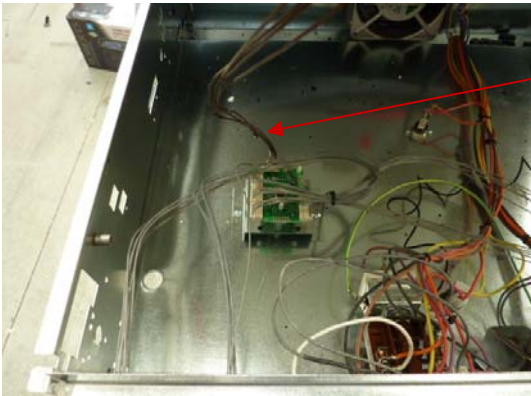

TO REMOVE THE HOB TOP ASSY COMPLETE WITH THE INDUCTION UNIT DISCONNECT THE LINBUS CABLE FROM THE PCB ENCODER

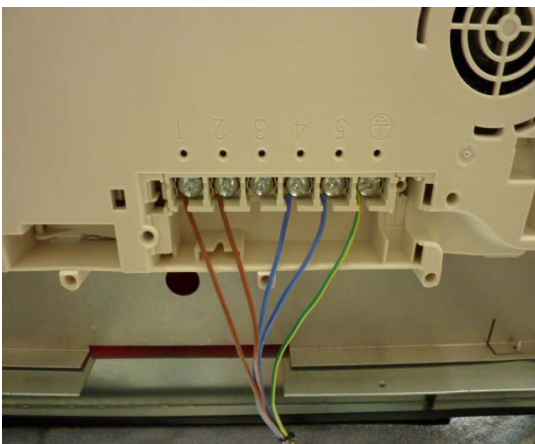

DISCONNECT THE POWER SUPPLY WIRES TO THE INDUCTION UNIT

THE HOB TOP COMPLETE WITH THE INDUCTION UNIT CAN NOW BE REMOVED FROM THE APPLIANCE

PLACE UPSIDE DOWN ON A PROTECTED SURFACE

8) REMOVAL OF INDUCTION UNIT FROM HOB TOP

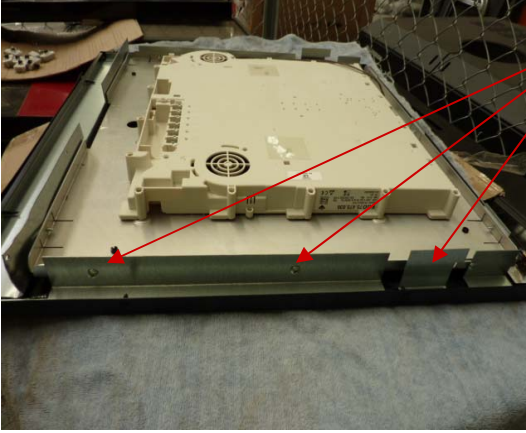

REMOVE 11X SCREWS FROM FRAME SUPPORT

LIFT AWAY INDUCTION UNIT FROM THE HOB TOP

INDUCTION UNIT REMOVED FROM HOB TOP

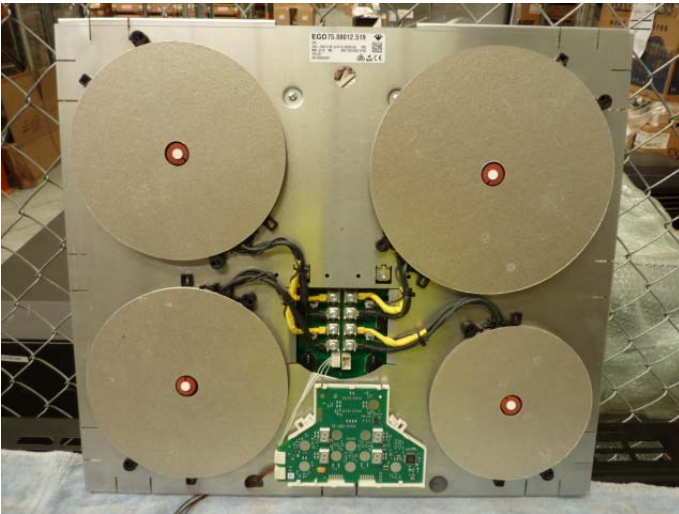

REPLACEMENT OF COMPONENTS

INDUCTION UNIT COMPONENTS

THE INDUCTION UNIT CONSISTS OF THE FOLLOWING COMPONENTS

- INDUCTORS
- MOUNTING PLATE
- USER INTERFACE
- GENERATOR

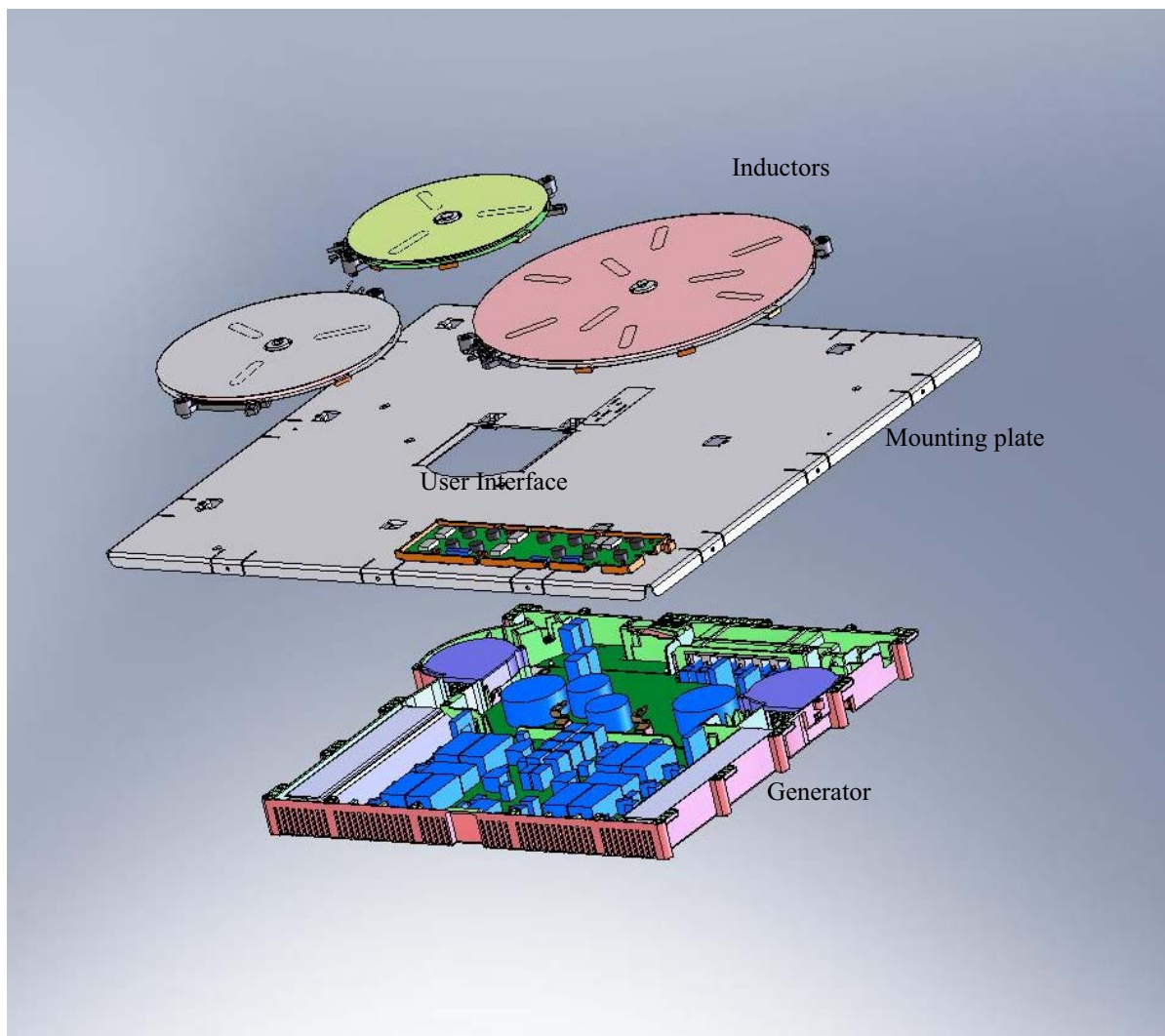

A) INDUCTION PODS

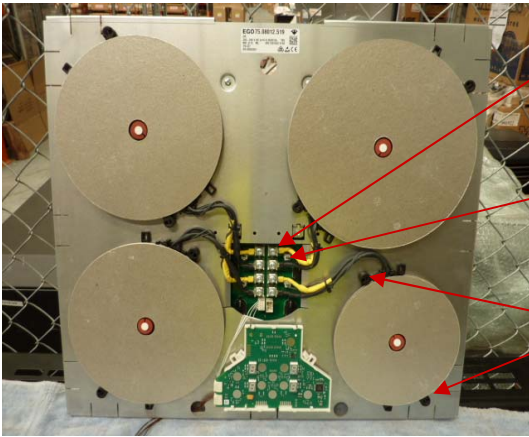

DISCONNECT WIRING FROM MAIN
TERMINAL BLOCK

DISCONNECT TEMP SENSOR FROM
CONNECTION

REMOVE INDUCTION POD BY
RELEASING CLIPS FROM MOUNTING
PLATE

B) USER INTERFACE

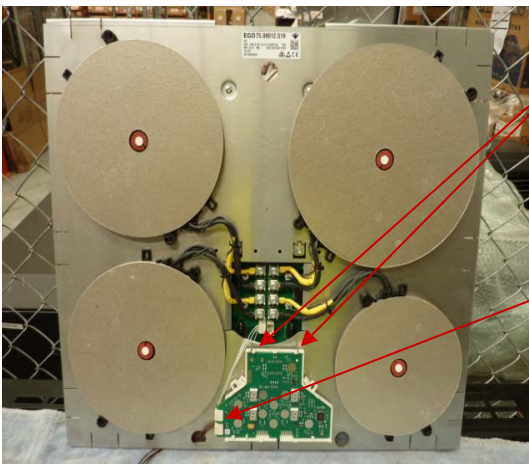

RELEASE 2 XCLIPS FROM PLASTIC
MOUNTING BOX

LIFT USER INTERFACE AWAY

DISCONNECT LINBUS CABLES FROM
L/H SIDE



C) MAIN POWER BOARD (GENERATOR)

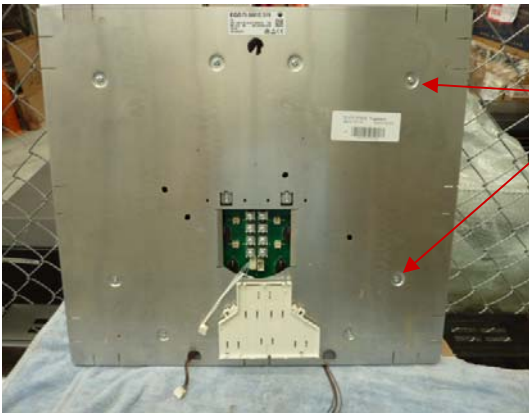

TO SEPARATE THE MAIN POWER BOARD FROM THE MOUNTING PLATE REMOVE 8X SCREWS AND LIFT THE MOUNTING PLATE AWAY

COOLING FAN

FILTER BOARD

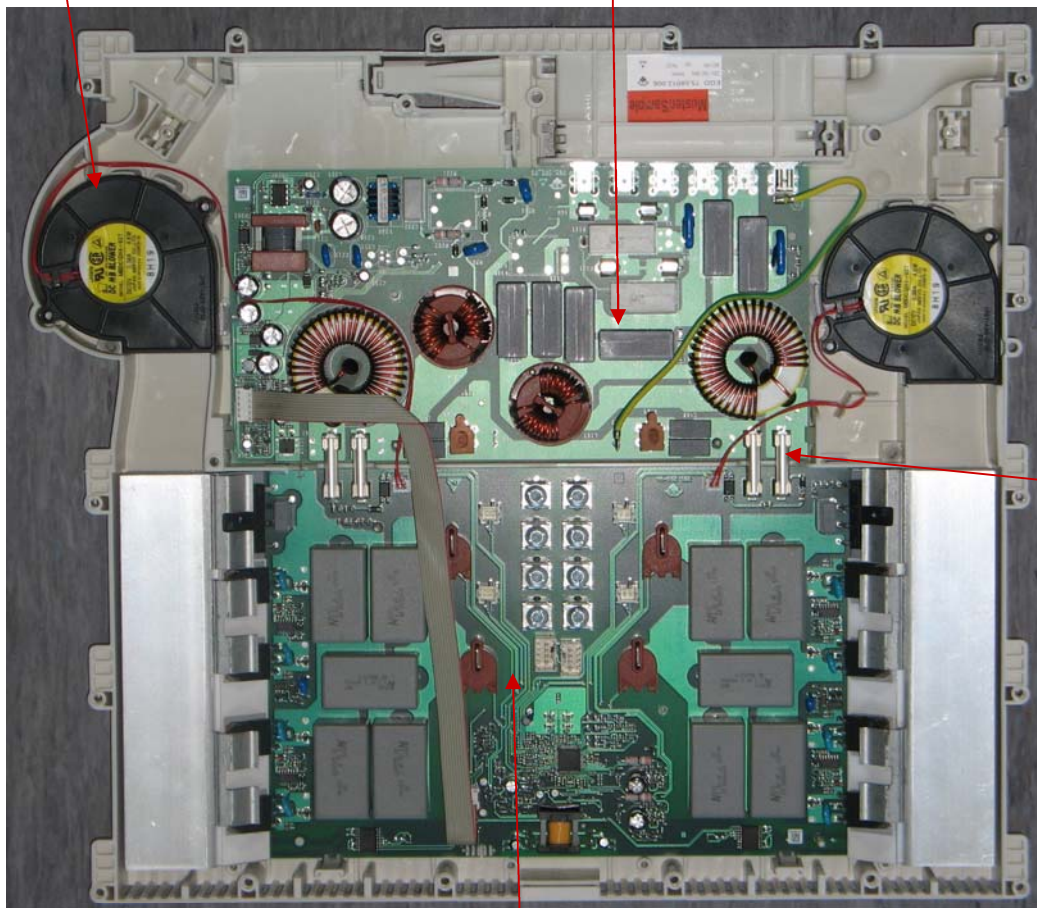

LINKS

MAIN POWER BOARD

D) TIMER

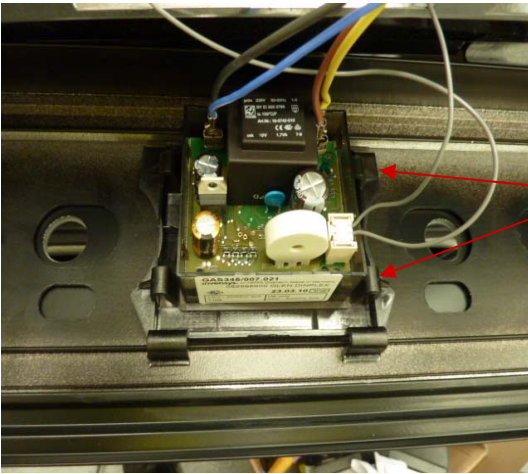

FOLLOW STEP 5 (PAGE 6) REMOVE FACIA PANEL

RELEASE TIMER FROM HOLDING CLIPS BY GENTLY PUSHING IN CLIPS WITH A SCREWDRIVER

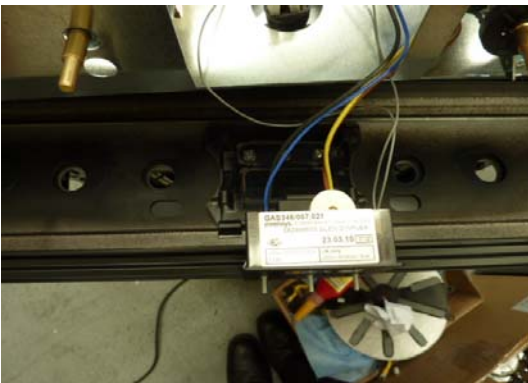

E) THERMOSTATS

MAIN OVEN T/STAT

TOP OVEN T/STAT

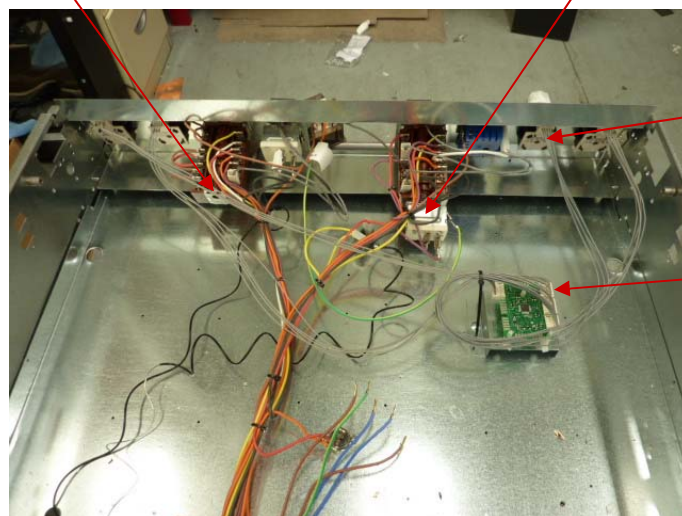

REGULATOR

PCB ENCODER

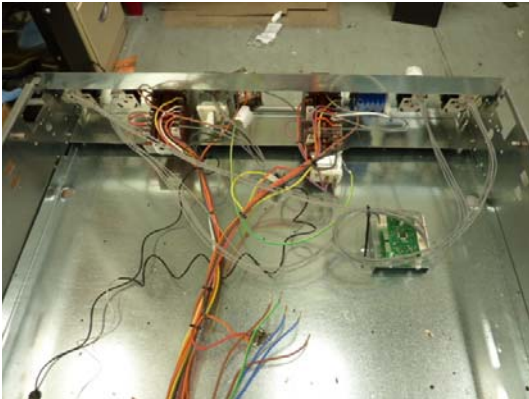

TO REMOVE THE TOP AND MAIN OVEN T/STATS FOLLOW STEP 7 (PAGE 8) AND REMOVE THE HOB ASSEMBLY

PULL THE THERMOSTAT OUT OF THE SELECTOR SWITCH

DISCONNECT THE WIRING AND REMOVE THE T/STAT PHIAL FROM THE RESPECTIVE OVEN CAVITY AND PULL THROUGH

F) GRILL ELEMENT



FOLLOW STEP 6 (PAGE 6) REMOVE REAR SERVICE PANEL

DISCONNECT WIRES

REMOVE GRILL ELEMENT GUARD BY LOOSENING 2 HIDDEN SCREWS (POSITIONS INDICATED) AND SLIDING OFF



REMOVE THE 2 SCREWS SECURING THE ELEMENT BRACKET TO THE CAVITY AND PULL THE ELEMENT FORWARD TO REMOVE

G) TOP OVEN LOWER ELEMENT

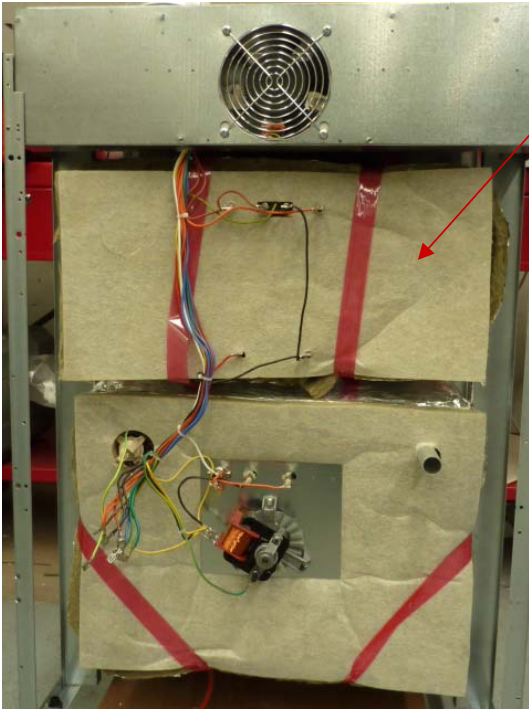

REMOVE INSULATION AT THE BACK OF THE TOP OVEN CAVITY

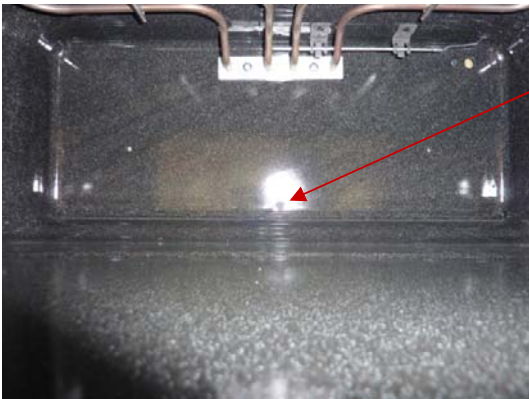

REMOVE SCREW FROM INSIDE TOP OVEN CAVITY AS INDICATED

PULL ELEMENT FROM REAR OF APPLIANCE

ALWAYS ENSURE WHEN REPLACING INSULATION TO USE CORRECT TAPE

H) MAIN OVEN GRILL ELEMENT

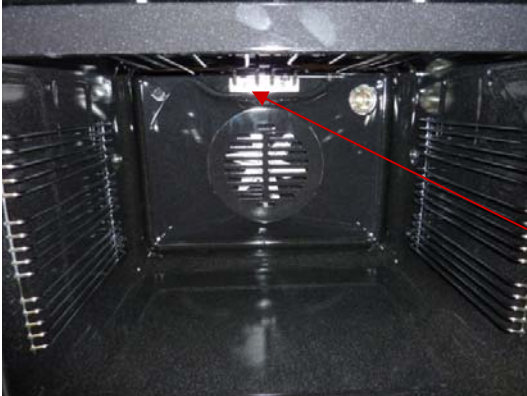

FOLLOW STEP 6(PAGE 6) AND REMOVE THE REAR SERVICE PANEL

DISCONNECT WIRING

REMOVE ELEMENT SECURING SCREWS

REMOVE ELEMENT FROM CAVITY

J) MAIN OVEN ELEMENT



FOLLOW STEP 6(PAGE 6) AND REMOVE THE REAR SERVICE PANEL

REMOVE 4 X REAR FAN COVER SECURING SCREWS AND REMOVE FAN COVER

DISCONNECT WIRING



REMOVE 2X MAIN OVEN ELEMENT SECURING SCREWS AND REMOVE THE ELEMENT FROM THE CAVITY

K) MAIN OVEN STIR FAN

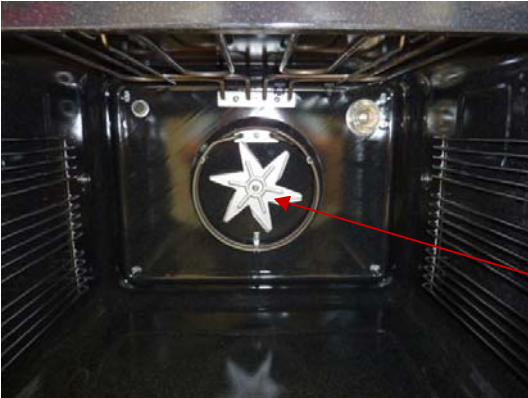

FOLLOW STEP 6(PAGE 6) AND REMOVE THE REAR SERVICE PANEL

REMOVE THE REAR FAN COVER AS ON PREVIOUS PAGE

REMOVE THE FAN IMPELLOR
N.B L/H THREAD NEEDS TO TURNED
CLOCKWISE TO REMOVE

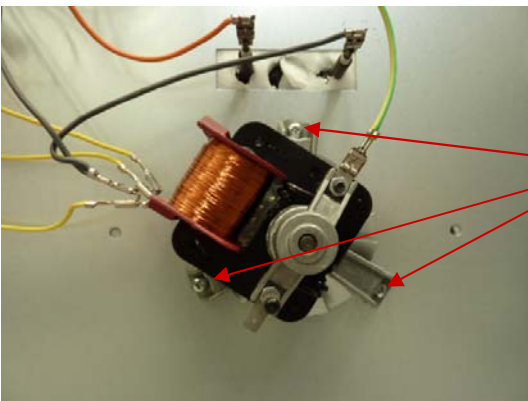

DISCONNECT WIRING FROM FAN

REMOVE 3 X STIR FAN SECURING
SCREWS AND REMOVE FAN FROM
THE REAR OF THE APPLIANCE

L) MAIN OVEN LIGHT FITTING

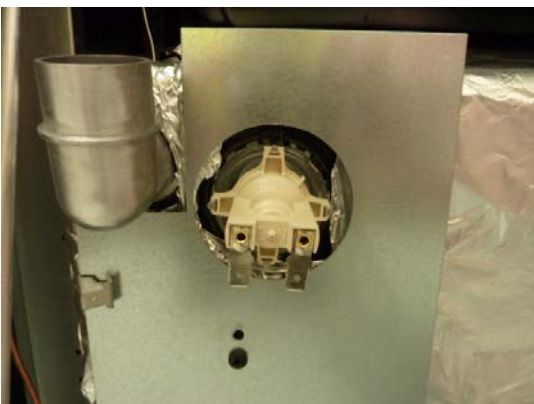

FOLLOW STEP 6 (PAGE 6) REMOVING
REAR SERVICE PANEL
REMOVE GLASS LAMP COVER BY
UNSCREWING
REMOVE THE EARTH LEAD
RELEASE 4 XCLIPS HOLDING LIGHT
FITTING IN PLACE
REMOVE BY PULLING LIGHT FITTING
FORWARD INTO CAVITY

M) MAIN OVEN LOWER ELEMENT

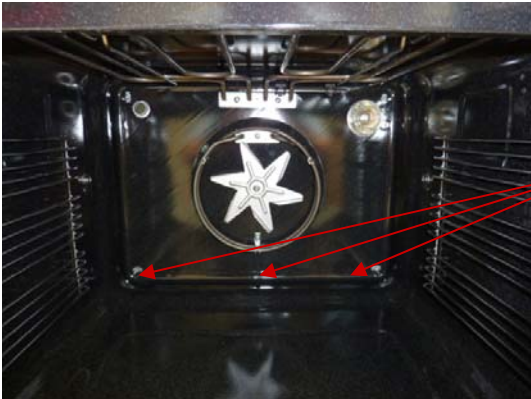

FOLLOW STEP 6 AND REMOVE THE REAR SERVICE PANEL
REMOVE REAR FAN COVER
REMOVE 3X SECURING SCREWS FROM INSIDE THE CAVITY

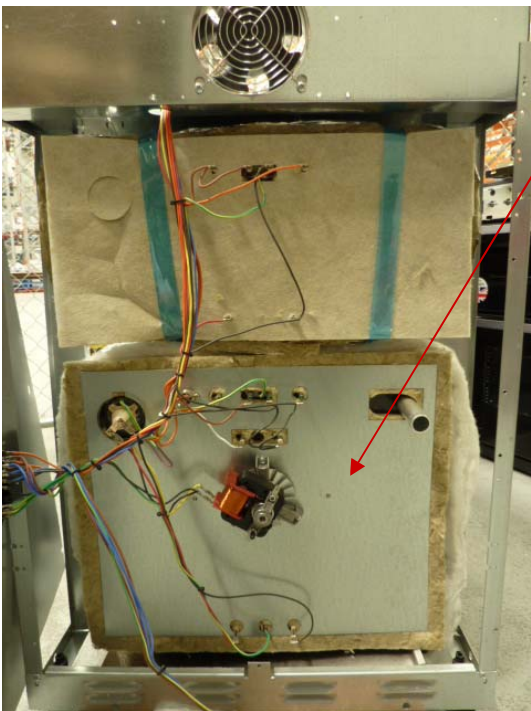

REMOVE THE REAR COVER AND ISULATION

PULL THE ELEMENT OUT FROM THE REAR OF THE CAVITY



**GLEN DIMPLEX
AUSTRALIA PTY LTD**

BELLING

FSE 60 I

**FAULTFINDING
GUIDES**



EGO G5 Induction Touch, Service Matrix, GDHA Ref 083006200, EGO Reference 75.08012.519

Part Description		Filter board	Power board	Fan	Inductor Ø 143/180 mm	Inductor Ø 180/150 mm	Inductor Ø 210/100 mm	User interface	LIN cable 400mm	LIN cable 265mm	Coax Switch (Encoder)	PCB Encoder	Cable Linbus 5 core	Cable Linbus 4 core 500mm Long	Warning! Ensure product is fully isolated from the mains circuit before opening up product.									
GDHA Part No		083080700	083080800	083081000	083081100	083081200	083081300	083081400	083081700	083081800	083083000	083084000	083086000	083089001	Tools Required:-									
EGO Spare Part/Kit No.		75.96475.017	75.96475.148	75.96950.021	75.96475.056	75.96475.057	75.96475.058	75.96468.682	75.96955.287	75.96955.336	440.20202.000	75.04003.102	N/A	N/A	Customer Service Step 1	Customer Service Step 2	Customer Service Step 3	Customer Service Step 4	Customer Service Step 5	Customer Service Step 6				
Hob Status Codes	Fault Description																							
	Indicates no pan or suitable pan on cook zone														Ensure correct pan size and that the pan is suitable for induction use (Check with a magnet), refer user to instructions									
	Power Boost														No faults (lasts for approx 10mins), refer user to instructions									
	Residual Heat														No fault Switches on/off when glass reaches 65/ 55 deg C, refer user to instructions									
	Automatic Boiling														No Fault , Auto Boil Programme, refer user to instructions									
	Child Lock														No Fault, Child Lock Activated, refer user to instructions									
	Low Temperature														No Fault, Low temperature setting activated, refer user to instructions									
Fault Codes	Fault Description																							
	control Knob error or stuck in the full on "overwind" positions for more than 30s									X (1)		X (1)			Ask the user/operator to check if one of the knobs is stuck in the full-on ("overwind") position, i.e. ask the user to ensure the control knob is in the off position, If fault disappears they have probably held the control knob in the full-on position for longer than 30s, advise user not hold in the overwind position for longer than 30s.	If the fault persist or the control knob is sticking binding book service visit	Check operation of control knob, check for binding, change components as appropriate							
ER20	Software Flash Failure							X (1)				X (1)			Ask user/operator to switch power off to the hob for 1 minute then switch back on, system should reset	Service visit required	First try manually configuring the touch control	Change user interface and PCB Encoder						
ER31	Configuration error		X (2)					X (1)				X (1)			Ask the user/operator to switch the power off and on, system should reset	Service visit required	First try manually configuring the touch control	Change user interface and PCB Encoder	If fault persists, change power board					
ER47	Communication error between Touch Control and Power board		X (3)					X (2)				X (2)	X (1)	X (1)	Ask the user/operator to switch the power off and on, system should reset	Service visit required	Check and replace linbus cables as required.	Change user interface and PCB Encoder	Change power board					
U400	Electrical Connection Error	X (1)	X (2)												Ask installer/operator to confirm correct connection to power supply, ensuring link is in place and securely tightened.	If external wiring and connection to appliance is correct service visit required	Service engineer to first Check wiring and connection (if not connected correctly consider charging customer)	Change filter board	Change power board					
E2	Induction coil has overheated, user has probably left an empty pan on and the unit has overheated.		X (2)		X (1)	X (1)	X (1)								Inform user about overheat safety protection, hob will auto reset when allowed to cool, No Fault	If fault persists a service visit required, Ask user which zone is showing persistent fault,	Change appropriate inductor	Change power board						
E5	Error on filter board	X (2)	X (1)												Ask user/operator to switch power off to the hob for 1 minute then switch back on, system should reset	Service visit required	check mains connection check IGBT and power supply (internal cabling) on power board	Check fuse on filter board, change fuse/filter board	Check IGBT and power supply (internal cabling) on power board, change power board					
E6	Error on power unit	X (2)	X (1)												Ask user/operator to switch power off to the hob for 1 minute then switch back on, system should reset	Service visit required	check mains connection check IGBT and power supply (internal cabling) on power board	Check fuse on filter board, change fuse/filter board	Check IGBT and power supply (internal cabling) on power board, change power board					
E8	Fan error	X (2)	X (3)	X (1)											Ask the user/operator to switch the power off and on, system should reset	Ask user if the fan working, check if anything is blocking fan inlet to product.	Service visit required	Check operation of fan, change appropriate fan if not working(Also check for correct operation of main fan)	Check fuse on filter board, change fuse/filter board	Check IGBT and power supply (internal cabling) on power board, change power board				
E9	Coil Temperature sensor defective		X (2)		X (1)	X (1)	X (1)								Ask the user/operator to switch the power off and on, system should reset	Service visit required	Change appropriate Inductor	Check IGBT and power supply (internal cabling) on power board, change power board						
EA	Power board failure, only		X (1)												Ask the user/operator to switch the power off and on, system should reset	Service visit required	Change power board							
8	Usually happens if there has been a power surge/Power cut in the area.	x (2)						X (1)				X (1)			Ask user to switch off the hob and leave off overnight then switch back on in the morning, system should reset.	If fault is not rectified ask user to switch and leave power off to the hob and book service visit	Service engineer to switch power on if correct operation, consider charging user for visit,	Change user interface and PCB Encoder	Check fuse on filter board, change fuse/filter board					

Note:- () brackets indicate the order in which component parts should be changed. All parts changed should be returned to GDHA, Prescott for the attention of the Quality Department, with details of the job and the fix applied.



INDUCTION



1

GLEN DIMPLEX
HOME APPLIANCES



INDUCTION

Induction Presentation

- What is Induction?
- How Does it Work?
- Performance.
- Our Products.
- Benefits.



INDUCTION

What is Induction?

- Put simply, an induction cooker element is a powerful electromagnet. When a good-sized piece of magnetic material is placed in the magnetic field that the element is generating, the field transfers ("induces") energy into that metal. That transferred energy causes the metal (the cooking vessel) to become hot.



INDUCTION

How Does It Work?

- When an electrical current is passed through a wire a magnetic field is produced.
- If an electrically conducting part is placed within the magnetic field, a current is developed in that part.

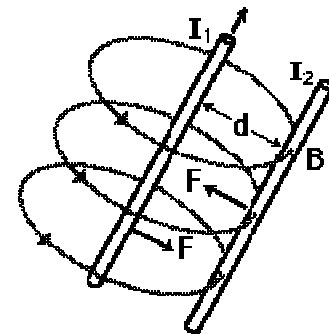
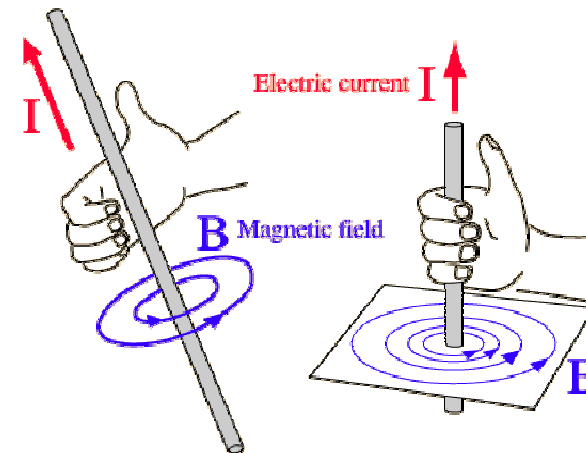

Forces Between Currents



INDUCTION

How Does It Work?

- **Power units or converters** - supply induction coils with high frequency current
- **Cooling unit** - for cooling the module
- **Control unit** - controls power units & communicates with Touch Control
- **Induction coils** - form the heating zones

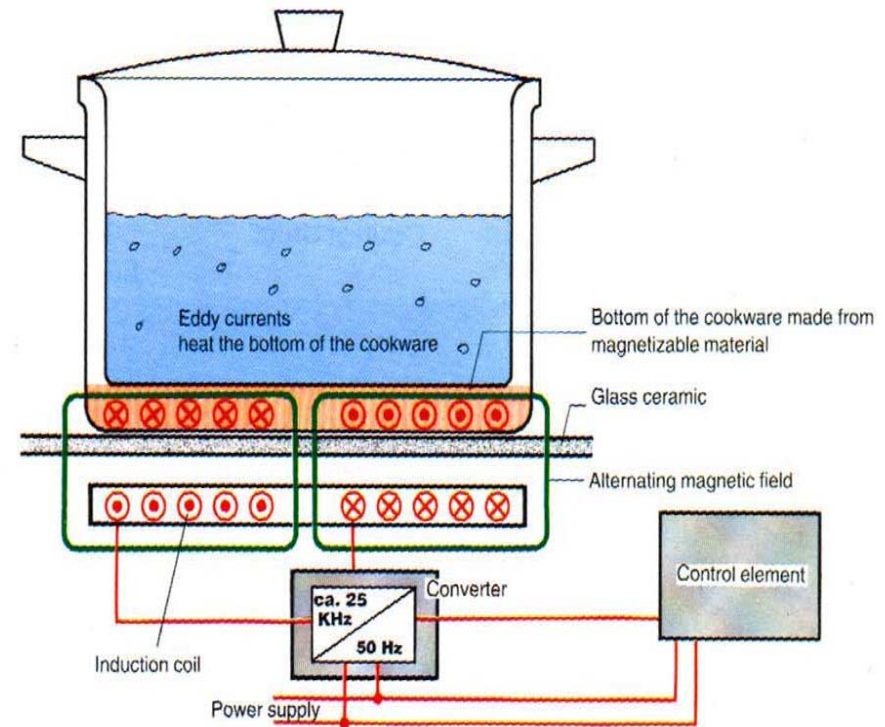

Induction Pod





INDUCTION

How Does It Work?

- Induction coil is installed under glass- ceramic panel
- Frequency converter converts mains frequency current to high frequency alternating current
- Induction coil is energized by the frequency converter
- Alternating current generates electromagnetic alternating field which penetrates the glass-ceramic
- Heat generating eddy currents induced in pan base
- Heat passes directly from the pan to its contents





Induction Performance Comparison

Technology	Efficiency	Time required to Boil 2 Litres of Water	Energy Consumption When Boiling 2 litres of water from 20 deg C
Induction	83-90%	4 Min 46 Sec	745kJ
Halogen	60%	9 Min 0 Sec	1120 kJ
Ceramic	55%	9 Min 50 Sec	1220kJ
Gas	40%	8 Min 18 Sec	1700kJ





INDUCTION

Performance

- **Induction**
Large Zone (Boost 3.0kW) - 2 minutes 50 seconds
The energy used was 0.12kW/h
- **Ceramic**
Standard large element (1.8kW)
5 minutes and 15 seconds
The energy used was 0.15kW/h

Both tests with 1 Litre of water using the 75K rise method. Using a 180mm Mayer pan





INDUCTION

Our Products

All new Induction products contain Jaeger Domino and controls

- EGO Basic System
 - Belling PBI 60 Hob Touch Control
 - Induction Oven Rotary Control
 - Sterling 900 & 1100E Touch Control
- EGO G IV & GV System
 - Stoves Hobs Touch and Rotary Control
 - Belling Freestanding Rotary Control





Pans

- Induction hobs (cook tops) work well with any pans with a high ferrous metal content at the point where the base is in contact with the Induction hob cooking surface. Cast iron pans and any black metal or iron pans will work on an induction hob. Stainless steel pans will often work on an induction hob provided the sole of the pan is a grade of stainless steel that has a high iron content, to check this do the magnet test: if a magnet sticks well to the sole of the pan it will work on an induction hob.





INDUCTION

Benefits

- Fast heat up
- Responsive control
- High efficiency
- Energy saving
- High power input (3.0 kW boost)
- Easy, precise Touch Control
- Ceramic panel stays cool
- Cool kitchen environment
- Easy clean cool hob surface
- In-built pan detection - auto switch off when pan removed from cooking zone
- Temperature sensor switches zone off if pan boils dry
- Independent automatic programming of zones

